



TSX™ Implant System

Surgical Manual

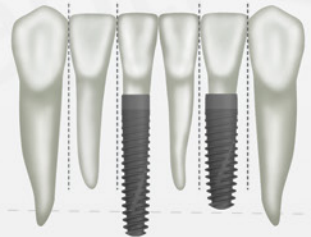
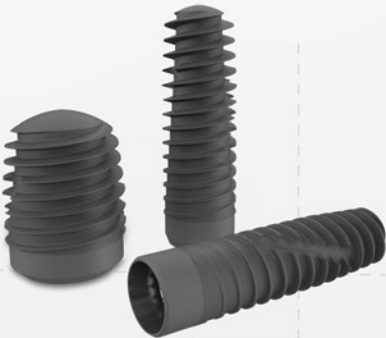

Table of Contents

Overview	3
General Implant Information	3
Indications for Use	3
Pre-Operative Planning	4
General Considerations	4
Anatomical Criteria	5
Bone Density Classification	7
Clinical Assessment	8
Diagnostic and Surgical Guides	8
Guided Surgery	11
TSX Implant Design and Specifications	12
Implant Dimensions	12
Platform Dimensions	12
Implant Packaging	13
Instrument Kit System	16
Color Reference Charts	16
Surgical Kit Layout Charts	17
Driva™ Gold Series Drills	17
Driva Drills (Original)	19
Drilling Sequence	21
Driva Gold Series Drills	21
Driva Drills (Original)	23
Guided Surgery Instrumentation	25
Drill Stop Kit	26
Surgical Procedures	29
General Surgical Instructions	29
Cleaning and Sterilization Guidelines	29
Site Preparation	30
Soft- and Dense-Bone Protocols	34
Immediate Extraction Placement	35
Implant Placement	36
Two-Stage and One-Stage Protocols	38
Guided Surgery Instructions	42
Bone Profilers	46
Healing Components	48

NOTE: Images shown throughout this manual are representational in nature and may not be to scale or display the exact geometry or color of the actual components.

Overview

General Implant Information

TSX Implants are designed to be placed at bone level or slightly below the crest of the bone. The occlusal aspect (platform) of the implant is the receiving area for the prosthetic component of the restoration. The implant has a dual acid-etched (DAE) surface at the coronal aspect followed by the MTX® Microtextured Surface. Sufficient alveolar bone width to surround the implant should be available for placement of the selected diameter. In addition, a minimum of 2.0 mm of bone is recommended beyond the apical aspect of the implant.



Bone-Level Implants

TSX Implants are available in the following body diameters: 3.1, 3.7, 4.1, 4.7, 5.4, and 6.0 mmD.

Indications for Use

The TSX Implants are designed for use in the maxilla or mandible for immediate loading or for loading after a conventional healing period. Implants may be used to replace one or more missing teeth. Immediate loading is indicated when there is good primary stability and an appropriate occlusal load. Implants may be placed immediately following an extraction or loss of natural teeth provided there is sufficient volume of alveolar bone to minimally support the implant (minimum 1 mm circumferential and 2 mm apical) and provide good primary stability. The 3.1 mmD TSX Implants should be splinted to additional implants when used in the pre-molar region and should not be used in the molar region.

NOTE: For additional information, including contraindications, precautions, and warnings, please consult the Instructions for Use accessible at labeling.zimvie.com.

Pre-Operative Planning

General Considerations

Team Approach

Successful implant treatment often requires the coordinated efforts of several dental professionals – the restorative dentist or prosthodontist, the surgeon (periodontist, oral surgeon or general dentist), the laboratory technician, and the dental hygienist. By holding a pre-surgical conference, enabled by a software such as RealGUIDE™, these individuals are able to develop an appropriate treatment strategy. This provides a balance between aesthetic, functional, and surgical goals. In addition, the coordinated effort ensures that the treatment approach is complete, guarding against omission of important technical considerations, such as the use of a surgical guide for implant positioning, and the biomechanical boundaries of the final prosthesis.

Patient Evaluation and Selection

- Take a general medical history.
- Explore indications and contraindications.
- Determine anatomical landmark considerations related to implant positioning.
- Determine feasible vertical dimensions.
- Consider biomechanical requirements of final restoration.
- Discuss treatment objectives and patient's expectations.
- Perform various radiographic and scanning evaluations.

Top-Down Treatment Planning

In its simplest form, top-down treatment planning refers to a guideline whereby the desired restorative result is considered first, leading to consideration of the appropriate prosthetic platform and subsequent implant selection based on bony anatomy and the size of the missing tooth. A software such as RealGUIDE is able to easily enable top-down treatment planning by including the restorative and surgical software tools in the same software environment.

A top-down treatment planning methodology will provide maximum biomechanical stability and allow for soft-tissue flaring by utilizing an implant with a prosthetic platform slightly smaller in diameter than the emergence diameter of the tooth being replaced. Implant and healing abutment selections are based upon the relationship of several key measurements:

- The emerging dimension of the crown in relation to the diameter of the prosthetic platform of the implant which can be easily manipulated in RealGUIDE by using emergence profile local or global manipulation tools.
- The height and diameter of the intended restoration at the soft-tissue exit point.
- The bone volume at the implant site in relation to the diameter of the implant body.

Proper stress distribution is essential to the long-term success of both the prosthesis and the implant. Overload is one of the key contributors to implant failure and is especially important in the cuspid and molar regions.

Anatomical Criteria

The design, quantity, diameter, and length of implants to be placed will depend on the type of restoration planned (implant- or tissue-supported; cement- or screw-retained), as well as the following anatomical criteria:

- Quality and quantity of available bone.
- A distance of 3.0 mm between implants and a distance of 2.0 mm between implants and adjacent teeth is recommended for optimal preservation of interproximal marginal bone levels and papillary soft-tissue height.
- Overdenture is to be implant-supported or tissue-supported/implant retained.
- Cement- or screw-retained restoration [Fig. A].

Minimum Surgical Space Between Implants

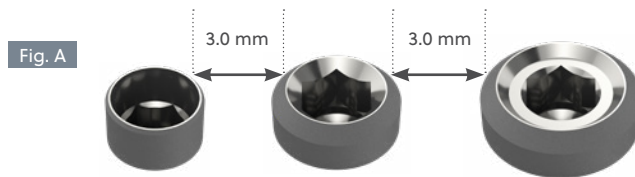

Allow 3.0 mm mesiodistal space between implants.

- Mesial and/or distal boundaries
 - (a) Mesial and distal borders of surrounding coronal contours. Example: In [Fig. B], the 3.1 mmD and 3.7 mmD implants are preferable due to mesiodistal constraints. At least 1 mm on either side of the platform is the minimum requirement for restorative contours.
 - (b) Convergent or divergent roots. Tapered implants allow for larger diameter in this area [Fig. C].
 - (c) Mental foramina.

Prosthetic Requirement of Implant Placement

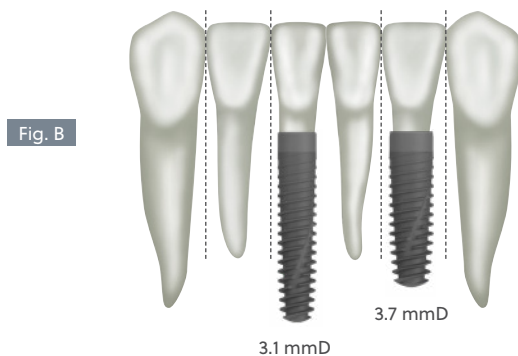

In this case, the 3.1 mm and 3.7 mm implants are preferable to allow 1 mm on either side of the platform.



Convergent roots advocate use of tapered implants.

- Buccal and/or lingual boundaries

- (a) Buccal and/or lingual restoration contours. Minimum requirement for restorative contours is 1.0 mm on either side of the platform diameter.
- (b) Restorations require space for sub-structures and substantial veneering materials (i.e., denture).
- (c) Buccal and/or lingual osseous depressions require the use of narrow or tapered implants [Fig. D].
- (d) Width of the crestal bone requires the use of implants that have a neck diameter which allows for a minimum of 1.0 to 1.5 mmD of bone on buccal and lingual borders [Fig. D].
- (e) Available bone to allow placement such that the occlusal force is axial through the center of the implant body.

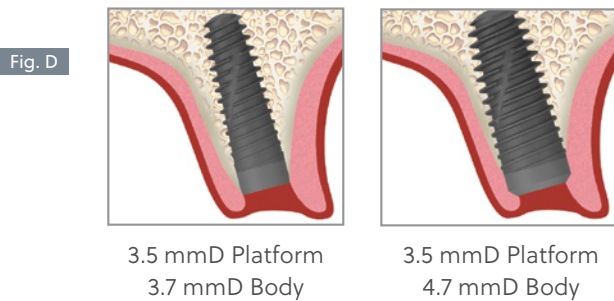

Fig. D Buccolingual bone requirements (1-1.5 mmD) in some cases advocate use of a narrower implant.

- Anatomical vertical limitations

- (a) Maintaining a distance of 1.0 mm to 2.0 mm between the maximum osteotomy depth and the superior boundary of the mandibular canal is recommended to avoid impingement of the neurovascular bundle [Fig. E].
- (b) Allow spacing below the floor of the sinus cavity unless sinus grafting procedures are planned.
- (c) Correct the plane of occlusion of opposing dentition to eliminate the restriction often created by over-eruption of unopposed dentition. This will allow for sufficient space for the final restoration.
- (d) If free-standing retentive anchors are proposed for the restoration, implants greater than 10 mm are recommended when sufficient ridge height is available to prevent excessive lateral load being applied to the implant.
- (e) Placement of the restorative platform at bone level [Fig. E] will ultimately determine the length and type of implant to be placed.

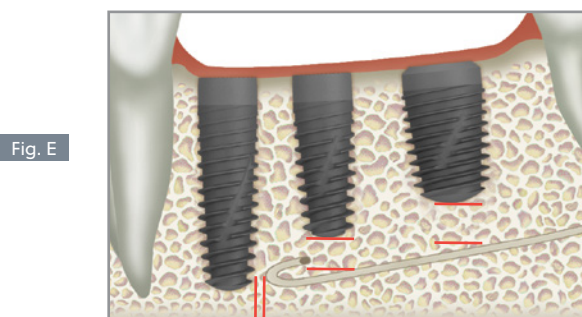

Fig. E Allow spacing of at least 2.0 mm above the mandibular canal (illustration not to scale). Implants are designed to be placed at bone level.

Bone Density Classification

Bone Density Classification

While one method of classifying bone density is shown in the images (below), different combinations of cortical and trabecular bone in varying thicknesses and densities can occur, and these typically differ by jaw location. The clinician is responsible for assessing bone density of the surgical site and choosing the appropriate protocol.

Protocols for Varying Bone Densities

The protocols in this Surgical Manual include drilling sequences for soft and dense bone. In the soft-bone surgical protocol, a straight, undersized osteotomy is prepared to help enhance initial stability of the implant through lateral bone compression. The dense-bone protocol prepares a larger, stepped osteotomy to obtain engagement no matter the length of implant being placed.



Type 1 (Dense) – Almost entirely homogeneous compact bone



Type 2 – Thick layer of compact bone surrounding a core of dense trabecular bone



Type 3 – Thin layer of cortical bone surrounding a core of trabecular bone



Type 4 (Soft) – Thin layer of cortical bone surrounding a core of low-density trabecular bone

PROTOCOL EXAMPLE

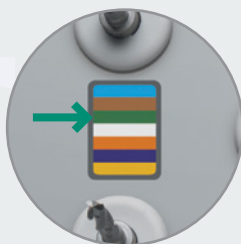

Step 1: The 3.7 mmD TSX Implants are color-coded green. Start with the first green bar on the kit, which indicates the first drill to be used in the drilling sequence for this implant size.

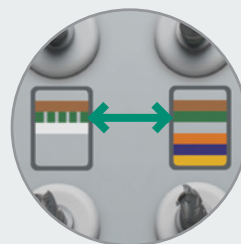

Step 2: Follow the green color bars from left to right. In a soft-bone protocol, the dotted green bar represents the final drill. For dense bone, skip the dotted green bar and move on directly to the next solid green bar. The last solid bar in the sequence represents the final drill for dense bone.

Clinical Assessment

Treatment Planning Considerations:

Proper treatment planning, as well as the selection of the proper implant length and diameter, are crucial to the long-term success of the implant and restoration.

Before an implant can be selected, the anatomical foundation available to receive the implant must be carefully assessed. Several steps should be taken to complete the evaluation:

1. Clinical examination of the oral cavity can provide important information about the health of the soft tissue at the proposed implant site. Tissue tone and the state of the superficial tissues should be evaluated. In addition, the patient should demonstrate an adequate dimension of attached gingiva or keratinized tissue at the site selected for implantation. In partially edentulous cases, the periodontal status of the remaining dentition should be assessed and interaction between the implant restoration and the adjacent natural dentition should be considered.
2. The bony foundation and ridge need to be clinically analyzed to ensure the presence of proper dimensions and the amount of bone for implant placement. At least one millimeter of bone should be present at the buccal and lingual aspects of the implant following placement. During the planning stage, it is useful to measure the existing bone foundation.

NOTE: Please ensure as many implants as necessary are used for a fully stable restoration.

CT Scans:

Computed tomography (CT) scans help surgeons view parts of the body with three-dimensional images. Image-guided surgical planning allows surgeons to see anatomical landmarks such as nerves, sinus cavities, and bony structures in order to plan for the placement of dental implants and prostheses.

Through the use of CT scans, clinicians are able to more precisely measure the locations of anatomical structures, dimensions of the underlying bone, and ascertain bone densities in order to plan and treat clinically demanding cases.

Diagnostic and Surgical Guides

Implant dentistry is guided by the restorative aspect of the procedure. Therefore, it is a prerequisite to evaluate the position of the surrounding anatomical landmarks and natural teeth relative to the proposed area for implant placement.

Rule of "P" – Proper Pre-treatment Planning Prevents Prosthetic Problems.

Fabricate diagnostic casts with a wax-up of the proposed position of the teeth in the implant prosthesis.

The implant team will utilize the diagnostic casts to fabricate the following, if required:

- Diagnostic guide with included markers for a variety of radiological exams – panoramic, periapical, computerized tomography (CT/CBCT scan), etc. These exams can supply the team with information regarding bone quality and quantity, location of vital structures (mental nerve canal, sinus cavities, labial or lingual bone contour, and surrounding roots if present), and soft-tissue height relative to the occlusal plane (see pages 9-10).
- A traditional, model-based surgical guide to be utilized at time of surgery for implant osteotomy preparation, taking into consideration mesiodistal and buccolingual angulation and placement of the implants while maintaining required distance between the implants. Some surgical guides can be resterilized and used by the restoring clinician to plan the contours of the final prosthesis. The guide may also be used in the decision-making process for abutment selection and preparation and/or recording of the final implant or abutment impressions (see pages 9-10).
- A software-based surgical guide to be utilized at time of surgery for implant osteotomy preparation. The guide is based on a 3D case plan and fabricated by a treatment planning provider such as Implant Concierge™ or dental laboratory, using a guided surgery software such as RealGUIDE (see page 11).

Fabrication of a Diagnostic and Surgical Guide

Digital Wax-Ups

With improvements in imaging technologies and software technologies, it becomes possible to eliminate some physical steps in more traditional methods listed below. Through virtualization of the patient, it is possible to perform implant planning from digital wax-ups. A software such as RealGUIDE can help with this process. More information can be found at www.realguide.com.

Recording an Impression

Use standard impression techniques to record an impression of the edentulous area with surrounding anatomical landmarks and the opposing arch.

1. For partially edentulous areas, make inter-occlusal records of the opposing arches in centric relation.
2. For fully edentulous areas, follow standard procedures for fabrication of an occlusal registration rim to create a wax denture try-in.

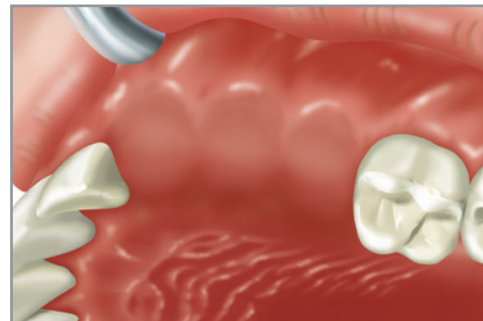

Mounting the Diagnostic Casts

To determine the distance between edentulous areas and opposing dentition, mount diagnostic casts utilizing the inter-occlusal records.

1. For partially edentulous arches, fabricate a diagnostic wax-up of the edentulous area using denture teeth or standard crown and bridge waxing techniques.
2. For fully edentulous arches, use an occlusal registration rim to make a bite registration, then create a patient-approved wax denture tooth try-in.

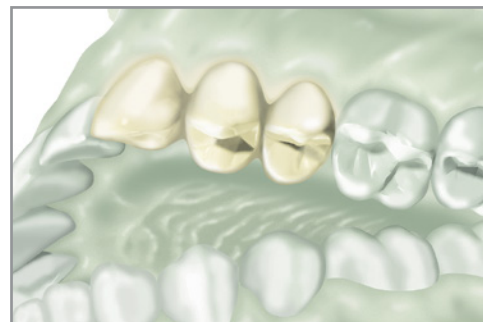

Duplicating the Diagnostic Wax-Up

Discuss surgical and restorative component options with the implant team prior to preparing the cast and wax-up for duplication.

Use an impression tray with alginate impression material to make an impression of the cast with incorporated wax-up of teeth and surrounding lost soft tissue. Fill the impression with stone and allow to harden.

Use the cast with diagnostic wax-up to fabricate a diagnostic, radiographic, surgical or alternatively a multi-function guide.

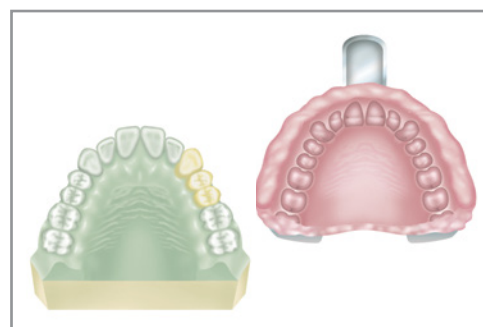

Fabricating the Clear Guide

Create a transparent guide using one of the following procedures:

1. A clear plastic 0.5 mm thick sheet is vacuum-formed over the duplicate stone cast of the tooth wax-up. Trim the guide according to clinical requirements. The vacuform can be used in its hollow version or using autopolymerizing or light cure acrylic to fill in areas previously occupied by wax and denture teeth.
2. Use a denture duplicator to create a clear version of the patient's current or new denture.

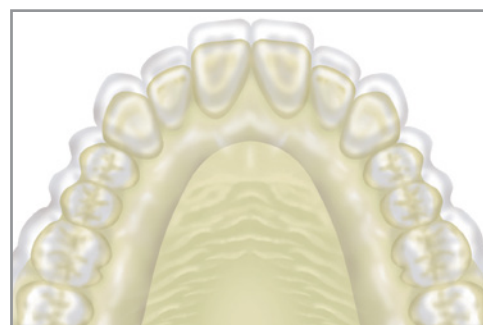

Placing the Radiographic Markers

Using metal radiographic markers when planning for a CT or similar type of scan is not recommended. Dimensionally calibrated metal ball bearings or an orthodontic wire will cause a sunburst or scatter effect rendering the scan unreadable.

Place material such as gutta percha or a mixture of radiographic powder (e.g., barium sulfate powder) and resin into pre-drilled diagnostic grooves or holes in the guide. The hole or markers should be placed inclusive of the incisal, cingulum, or occlusal height of replacement teeth, taking into consideration the vacuform sheet thickness and the point in contact with the soft tissue. Metal markers can be used with standard scan procedures such as a panoramic or periapical.



Seating the Clear Guide

Place the guide with included radiographic markers into the patient's mouth, and lock into position by engaging the undercut created by the height of contour of the surrounding natural teeth.

Make the required scan best suited for the proposed case design to acquire a working knowledge of the anatomical limitations in the areas of proposed implant placement.



Making the Required Measurements

Radiographic markers can help the clinician determine:

- Height of the teeth to be replaced
- Thickness of the soft tissue (by subtracting the end of the marker from the start of the bone)
- Position of the restorative margin
- Number of implants
- Length of the implant
- Diameter of implant
- Inter-implant space

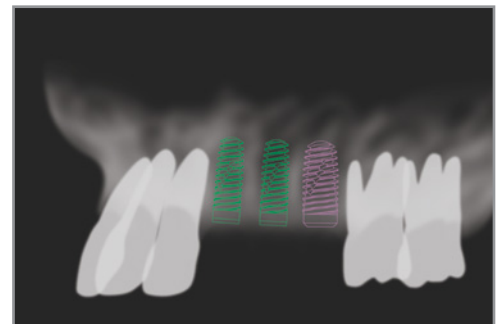

Trimming the Clear Guide

Remove the material from the radiographic/diagnostic guide in the area that is planned for surgery.

The clinician responsible for implant placement determines if they want vertical holes drilled or sections removed from the original guide to assist them in implant placement.



Guided Surgery

Fabrication of a Diagnostic and Software-Based Surgical Guide

Fabricating the Diagnostic Guide/Scan Prosthesis

A scan prosthesis is generally a radiopaque duplicate of the provisional teeth set-up or patient's existing denture for visibility of the desired tooth location in the CT images and selected case planning software. Follow the software supplier's general scanning instructions including fabrication of the scan prosthesis, patient preparation, positioning, image reconstruction, and scanning parameters.



Fabricating the Software-Designed Surgical Guide

A software-designed, case-specific surgical guide is fabricated by a specialized provider such as Implant Concierge or a dental laboratory by using guided surgery software such as RealGUIDE.

For more information on fully guided surgery solutions for TSX Implants, visit the RealGUIDE Z3D Guided Surgery Kit page at zimvie.com. For guided surgery technique information utilizing the Guided Surgery Drill Module and Tube Adapters, please reference the Instructions for Use available at www.zimvie.com and pages 41-45 in this manual. For case-specific detailed surgical guide instructions for use please contact your software and/or surgical guide manufacturer.



TSX Implant Design and Specifications

TSX Implants feature a 1.5mm dual acid-etched (DAE) coronal aspect followed by the MTX Surface. TSX Implants taper along the length of the inner and outer diameter of the implant originating below the first thread. The degree of taper on the implants varies depending on their length to ensure that the apical diameter is consistent among all implant lengths. Therefore, the shorter the implant, the greater the degree of taper.

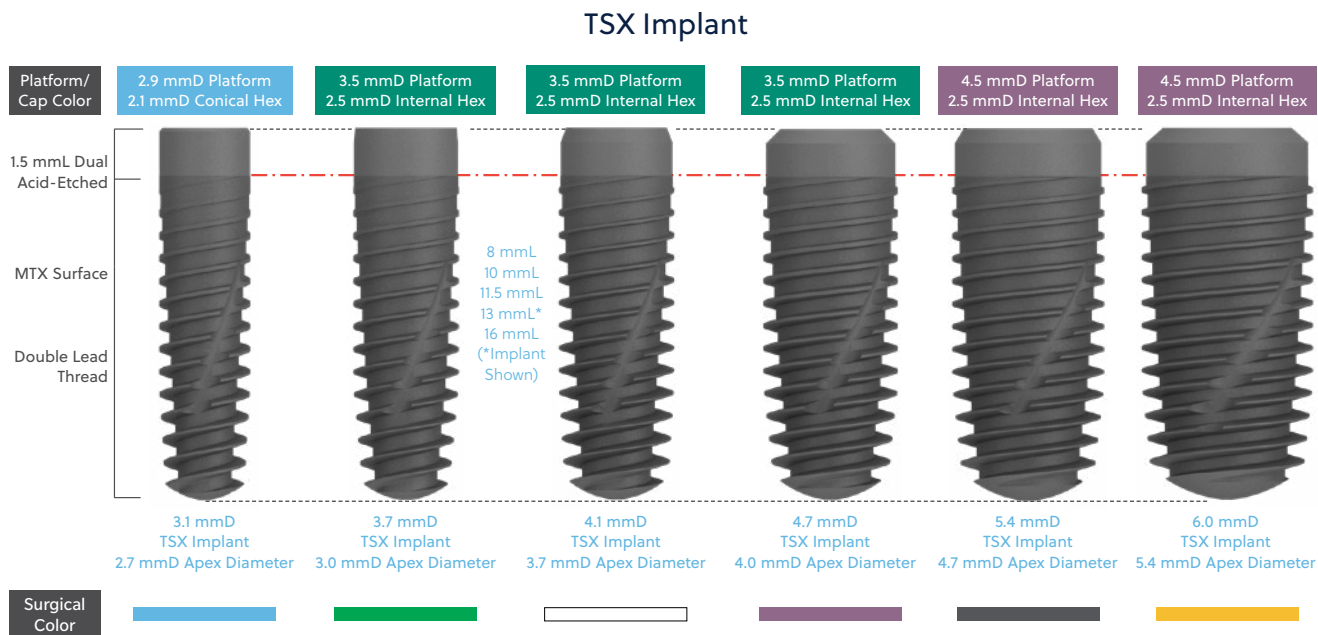

Platform Dimensions

The implant platform diameter is measured across the most coronal part of the implant. TSX Implants have three implant platform diameters and designs:

- **2.9 mmD platform [Fig. 1A & B]** - A 1.3 mm deep, 17° internal cone extends from the outermost diameter (2.9 mmD) of the implant platform to the internal hex of the implant. The internal hex is 2.1 mm flat-to-flat with a depth of 1.7 mm. Below the hexagon leads to the threaded area where the appropriate fixation screw with M1.6 mm thread is received.

- **3.5 mmD platform [Fig. 2A & B]** - A 44° internal conical bevel extends from the outermost diameter (3.5 mmD) of the implant platform into the internal hex of the implant. The internal hex configuration is 2.5 mmD flat-to-flat with a depth of 1.5 mm. Below the hexagon is a continuation of the inner chamber which leads into the threaded area where the appropriate fixation screw with 1-72 UNF thread is received.

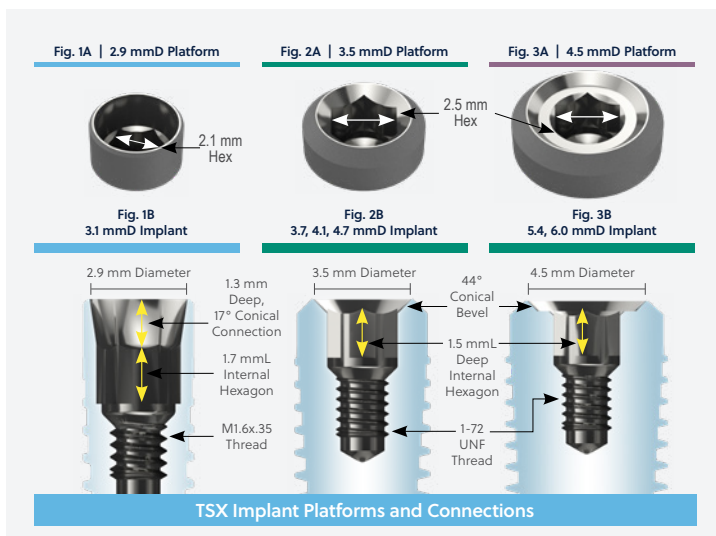

- **4.5 mmD platform [Fig. 3A & B]** - A 44° internal conical bevel extends from the outermost diameter (4.5 mmD) of the implant platform into a flattened area or ledge. This ledge extends from the base of the lead-in bevel to the internal hex of the implant. The internal hex configuration is 2.5 mmD flat-to-flat with a depth of 1.5 mm. Below the hexagon is a continuation of the inner chamber which leads into the threaded area where the appropriate fixation screw with 1-72 UNF thread is received.

Implant Packaging

TSX Implants

Remove the implant outer vial from the box.



Locate the patient record labels, indicating product description and lot number, and adhere to the patient's chart.



Open the outer vial to break the seal.



Drop the sterile inner vial and contents onto a sterile field. Optionally, the implant vial may be placed into a sterile Staging Block.

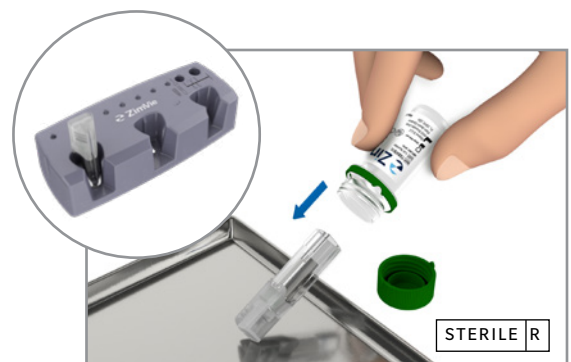

Flip the white top of the inner vial open by pressing on the flat side with access hole. Press the top to the inner vial body to lock in place.

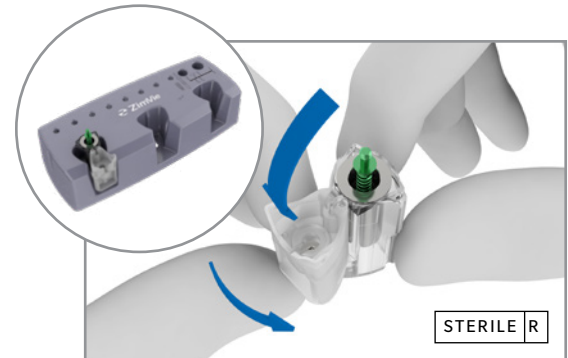

TSX Implant packaging includes an optional Alignment Pin designed to guide implant parallelism when placing multiple implants. To remove from the packaging, pick up the Alignment Pin with a clean gloved hand and place in the sterile field. See Alignment Pin instructions on page 37.

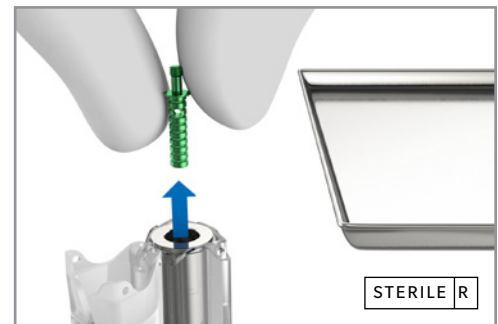

Place the appropriate insertion instrument over the implant in the vial.



Engage the implant directly with the insertion instrument.

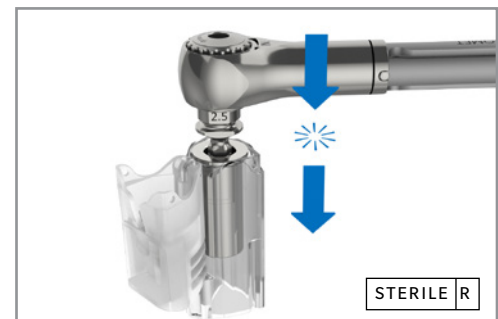

Lift the implant from the inner vial and carry it to the reception site. Initiate the implant into the osteotomy and complete seating with the appropriate instruments.



Locate the surgical cover screw in the cap of the inner vial. Using the 1.25 mmD Hex Driver with GemLock retention [HXGR1.25, HXLGR1.25], engage the cover screw.

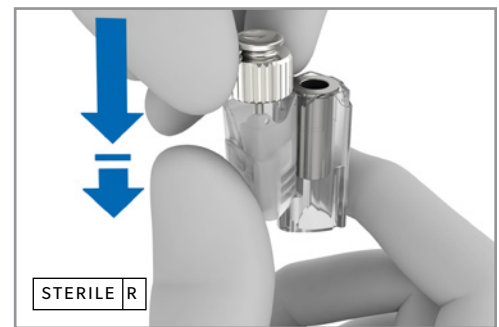

Engage the cover screw with the 1.25 mmD Hex Driver with GemLock retention [HXGR1.25, HXLGR1.25] and push down to open door. The surgical screw will be engaged.

For cover screw placement instructions, please refer to page 38.

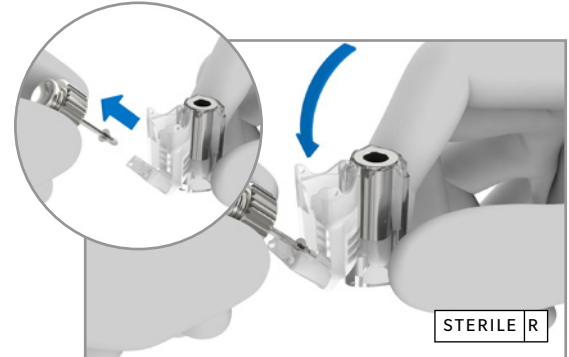

Instrument Kit System

Color Reference Chart:

TSX Implants

Implant Diameter	3.1 mmD	3.7 mmD	4.1 mmD	4.7 mmD	5.4 mmD**	6.0 mmD
Surgical Sequence Color Bar*						
Drill Band Color for Dense-Bone Protocol**						
Implant Cap Color and Restorative Platform	 2.9 mmD NP ⊙	 3.5 mmD ◊	 3.5 mmD ◊	 3.5 mmD ◊	 4.5 mmD ◊	 4.5 mmD ◊
TSX Vial Cap Label						

*NOTE: Implant cap color indicates restorative platform. Surgical and restorative color coding do not match on diameters 4.1mm and larger.

Instrument Color Reference Chart:

TSX Implants

Band Color	Instrument Description
	Driva Step Drill, 2.8/2.4 mmD
	Driva Step Drill, 3.4/2.8 mmD
	Driva Step Drill, 3.8/3.4 mmD
	Driva Step Drill, 4.4/3.8 mmD
	Driva Step Drill, 5.1/4.4 mmD **
	Driva Step Drill, 5.7/5.1 mmD



Drilling Sequence Guidelines

Soft-Bone Protocol: Follow solid color bars on the surgical tray surface until the segmented color bar. The segmented color bar indicates the final drill for soft-bone protocol.

Dense-Bone Protocol: Follow solid color bars only. The last solid bar in the sequence represents the final drill for dense-bone.



**The first generation TSV51D44G and TSV51D44SG final dense bone drills for the 5.4 mmD TSX Implant do not have color-coding. Second generation TSV51D44G and TSV51D44GS final dense bone drills with color-coding may also be used, in addition to the original Driva TSV5.1DN and TSV5.1DSN drills without color-coding may be used as the final drill in dense bone. Refer to pages 22 and 24 for the 5.4 mmD implant drilling sequence information as 5.4 mmD color bar is not displayed on TSVKIT or TSVKITG.

TSV Surgical Kit Layout Chart for TSX Implant Placement Driva™ Gold Series Drills

Tapered Screw-Vent Surgical Kit (TSVKITG)

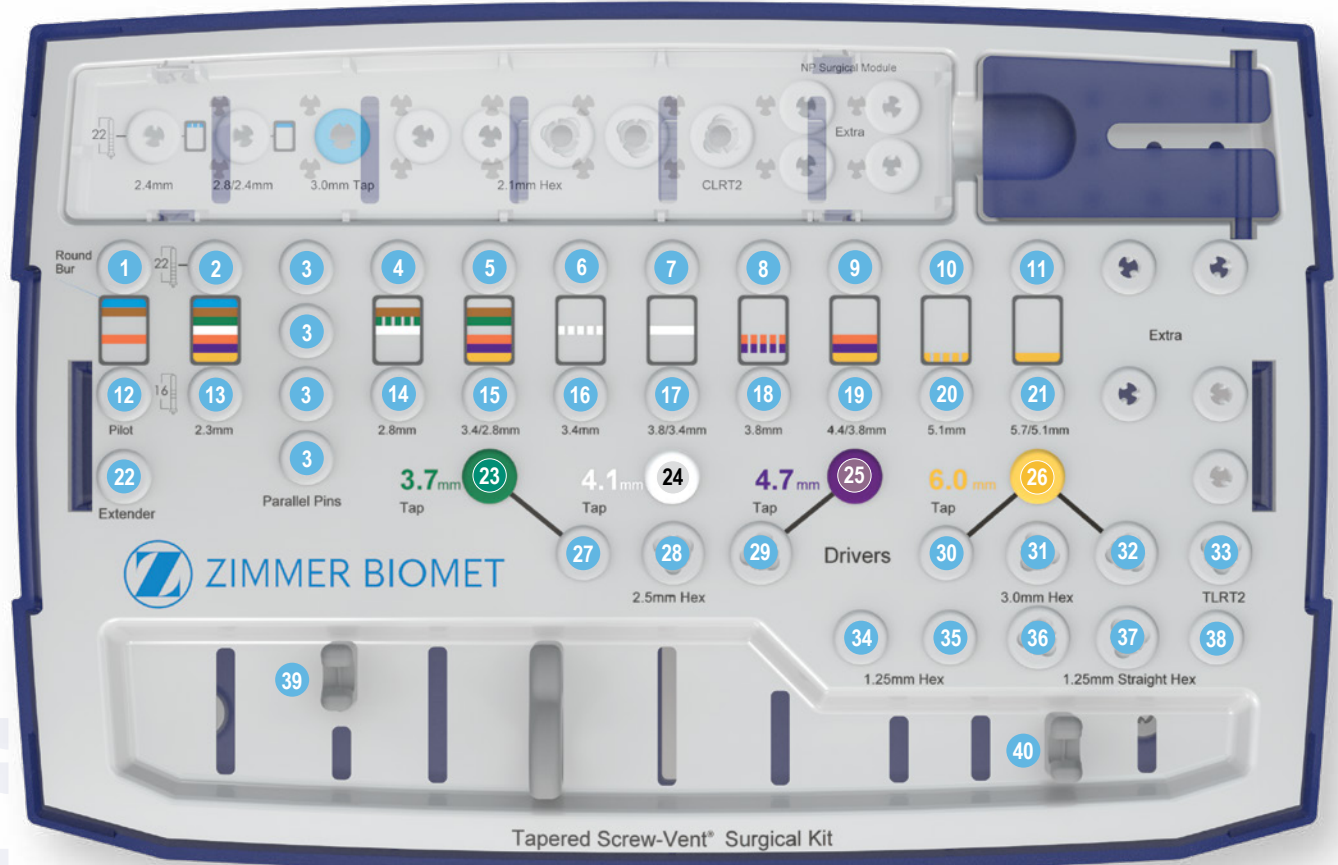
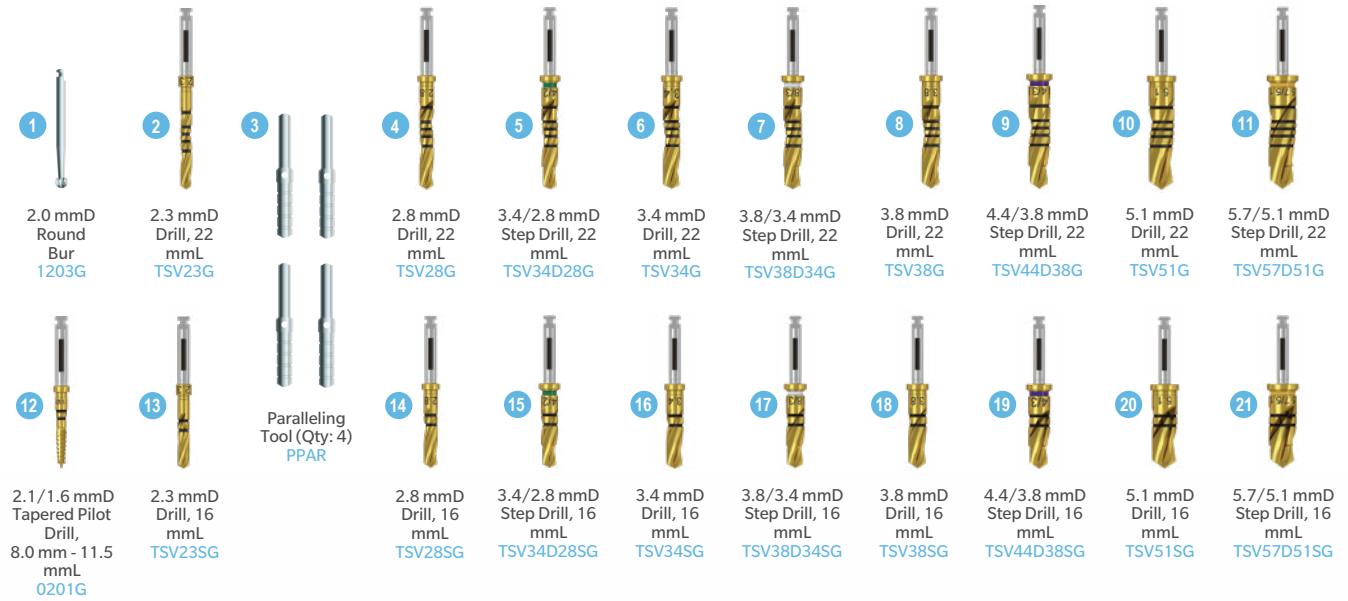

NOTE: TSV44G, TSV44SG, TSV51D44G and TSV51D44SG with or without color final drill color coding or TSV51DN and TSV51DSN final bone drills for the 5.4 mmD TSX Implant are not included in TSVKITG or the TSVKIT and must be purchased separately.

NOTE: TSV Taps not utilized with TSX Implant

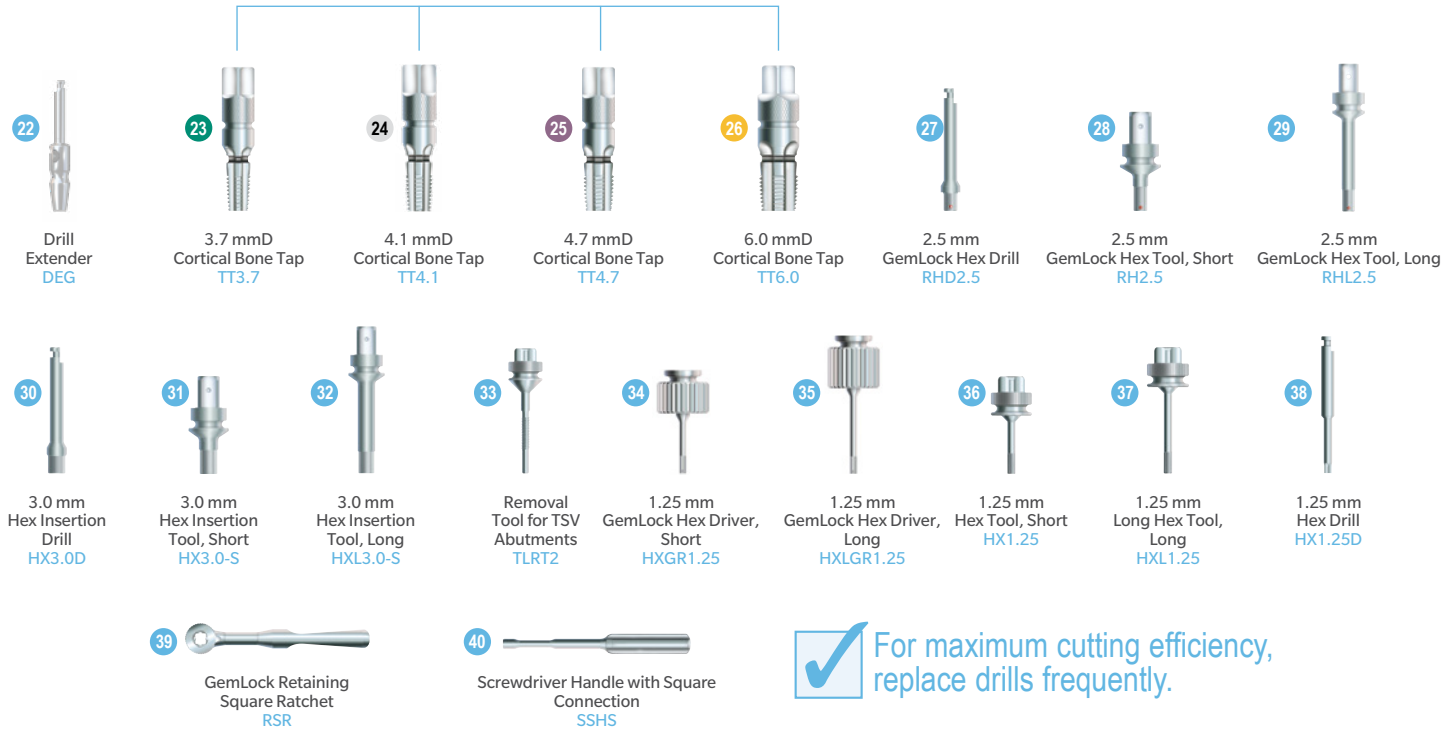

NP Surgical Module for 3.1 mmD TSX Implant (NPMODG)

NOTE: Eztetic Tap not used with TSX Implant

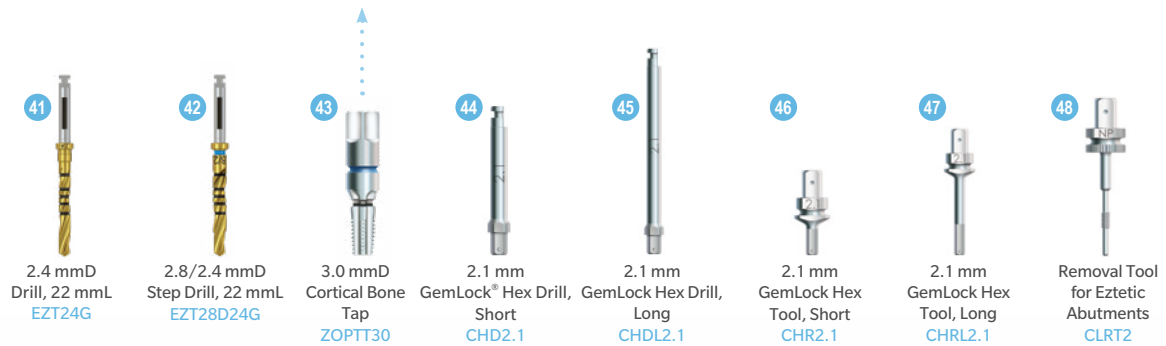

The NP Surgical Module snaps into the Surgical Kit

TSV Surgical Kit Layout Chart for TSX Implant Placement Driva Drills (Original)

Tapered Screw-Vent® Surgical Kit (TSVKIT)

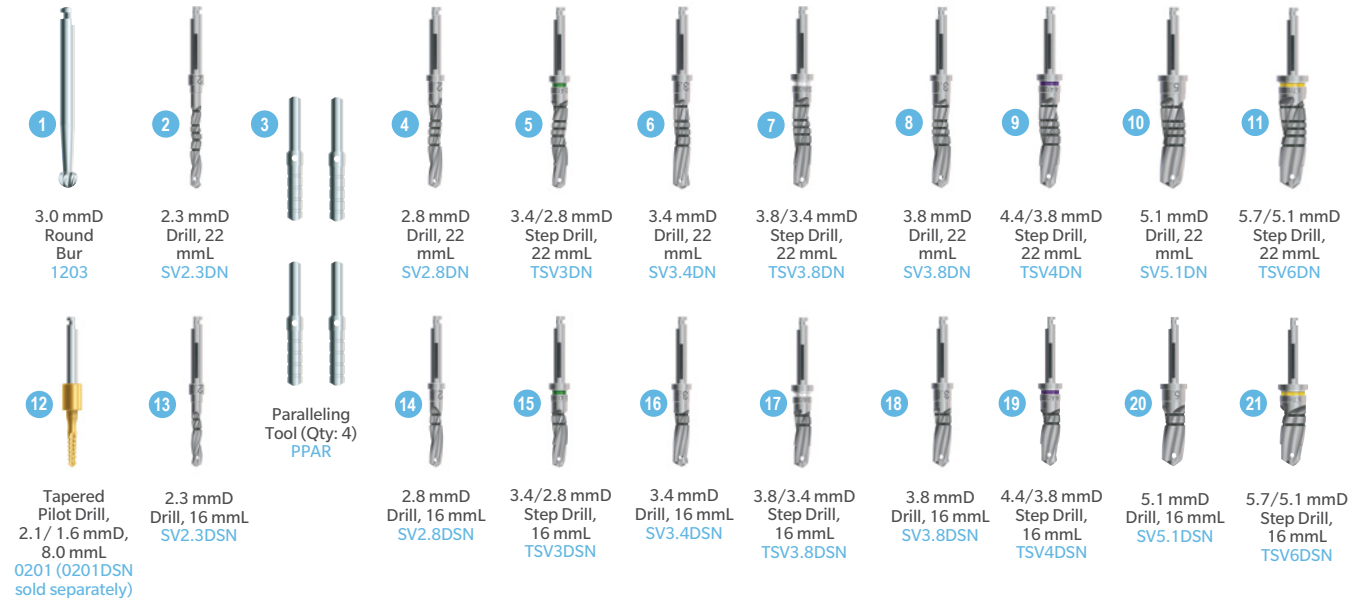

NOTE: TSV51D44G and TSV51D44SG or TSV51DN and TSV51DSN final dense bone drills for the 5.4 mmD TSX Implant are not included in TSVKITG or the TSVKIT and must be purchased separately.

NOTE: TSV Taps not utilized with TSX Implant

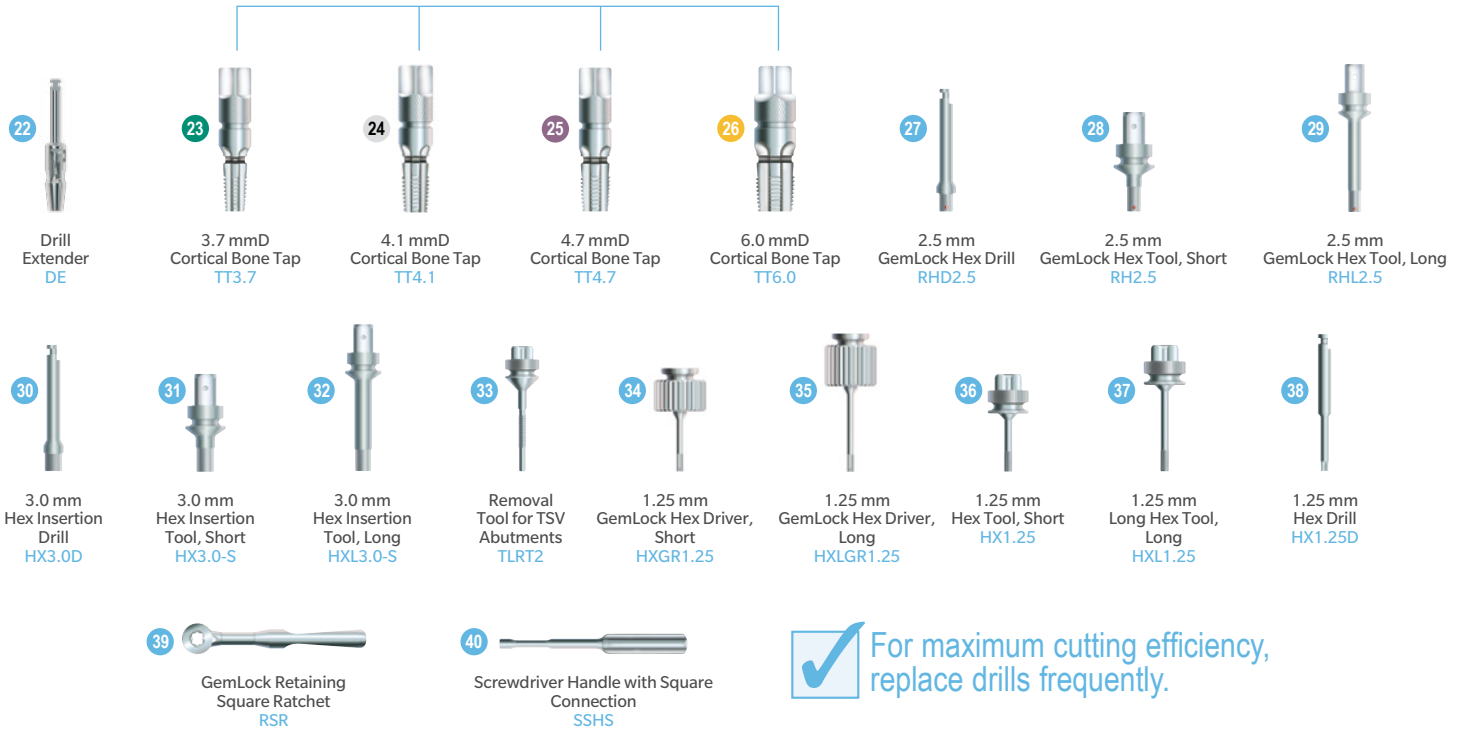

 For maximum cutting efficiency, replace drills frequently.

NP Surgical Module for 3.1 mmD TSX Implant (NPMOD)

NOTE: Eztetic Tap not used with TSX Implant

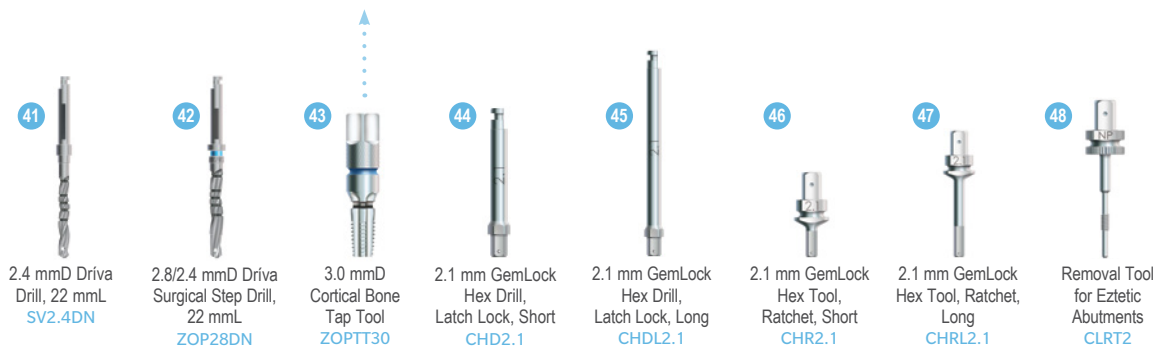

The NP Surgical Module snaps into the Surgical Kit

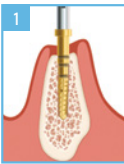
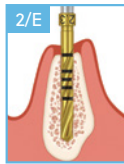
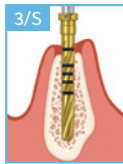
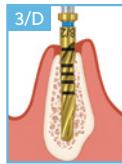

TSX Drilling Sequence - Driva Gold Series Drills

The TSX Implant offers drilling sequences for extraction, soft, and dense bone placement. The final drill in the tested sequence is indicated by an E (extraction), S (soft bone) or D (dense bone). Note: TSX immediate extraction placement drilling protocols were designed and tested by engaging only the apical 4 mm of the TSX Implant in dense bone block. Thorough anatomical, bone quality, and bone quantity assessments and surgical planning must be conducted before utilizing this or any surgical drilling protocol. The selection of drilling sequence, placement positioning, and loading protocols are at the discretion of the clinician. For additional information, please consult the Instructions for Use at labeling.zimvie.com.

3.1 mmD TSX Implants				
 <p>Restorative Platform</p> <p>2.9 mmD</p>	 <p>0201G 2.1/1.6 mmD, 8.0 mmL - 11.5 mmL Drill</p>	 <p>TSV23G 2.3 mmD Drill</p>	 <p>EZT24G 2.4 mmD Drill</p>	 <p>EZT28D24G 2.8/2.4 mmD Step Drill</p>
	Extraction*	<input checked="" type="checkbox"/>	<input checked="" type="checkbox"/>	<input type="checkbox"/>
Soft	<input checked="" type="checkbox"/>	<input checked="" type="checkbox"/>	<input checked="" type="checkbox"/>	<input checked="" type="checkbox"/>
Dense	<input checked="" type="checkbox"/>	<input checked="" type="checkbox"/>	<input type="checkbox"/>	<input checked="" type="checkbox"/>

NOTE: The top of the laser/score line markings (0.5 mm in height) on the drills are in excess of the length of the implant to be placed by 1.25 mm (8.0 mmL is actually 9.25 mmL). This added length is to accommodate for the design of the drill point. This additional drill length also allows for placement flexibility slightly below the bone crest. The 2.3 mmD Drill is the only drill that is close to the actual implant length (i.e., 8.0 mmL is actually 8.25 mmL).

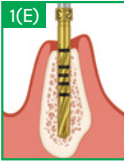
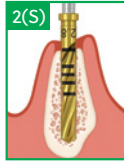
* When utilizing the 2.3 mmD Drill as the final drill in the 3.1 mmD and 3.7 mmD extraction protocol, take into account the 2.3 mmD drill length as noted above.

3.7 mmD TSX Implant (3.5 mmD Platform)			
 <p>Restorative Platform</p> <p>3.5 mmD</p>	 <p>TSV23G 2.3 mmD Drill</p>	 <p>TSV28G 2.8 mmD Drill</p>	 <p>TSV34D28G 3.4/2.8 mmD Drill</p>
	Extraction*	<input checked="" type="checkbox"/>	<input type="checkbox"/>
Soft	<input checked="" type="checkbox"/>	<input checked="" type="checkbox"/>	<input checked="" type="checkbox"/>
Dense	<input checked="" type="checkbox"/>	<input type="checkbox"/>	<input checked="" type="checkbox"/>

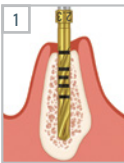
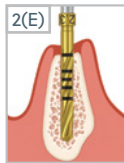
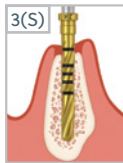
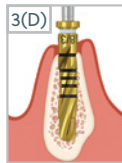
4.1 mmD TSX Implant (3.5 mmD Platform)				
 <p>Restorative Platform</p> <p>3.5 mmD</p>	 <p>TSV23G 2.3 mmD Drill</p>	 <p>TSV28G 2.8 mmD Drill</p>	 <p>TSV34G 3.4 mmD Drill</p>	 <p>TSV38D34G 3.8/3.4 mmD Drill</p>
	Extraction	<input type="checkbox"/>	<input type="checkbox"/>	<input type="checkbox"/>
Soft	<input type="checkbox"/>	<input type="checkbox"/>	<input type="checkbox"/>	<input type="checkbox"/>
Dense	<input type="checkbox"/>	<input type="checkbox"/>	<input type="checkbox"/>	<input type="checkbox"/>

Long drills shown. Short drills are also available.

4.7 mmD TSX Implant (3.5 mmD Platform)					
<p>Restorative Platform</p> <p>3.5 mmD</p>	<p>1 TSV23G 2.3 mmD Drill</p>	<p>2 TSV34D28G 3.4/2.8 mmD Drill</p>	<p>3(E) TSV34G** 3.4 mmD Drill</p>	<p>3(S) TSV38G 3.8 mmD Drill</p>	<p>3(D) TSV44D38G 4.4/3.8 mmD Drill</p>
	Extraction	■	■	■	
Soft	■	■		■ ■ ■ ■	
Dense	■	■			■

**Note: TSV34G is utilized only in the extraction protocol for the 4.7 mmD TSX Implant is not marked with a purple color line on the surgical kit.

5.4 mmD TSX Implant (4.5 mmD Platform)					
<p>Restorative Platform</p> <p>4.5 mmD</p>	<p>1 TSV23G 2.3 mmD Drill</p>	<p>2 TSV34D28G 3.4/2.8 mmD Drill</p>	<p>3 TSV44D38G 4.4/3.8 mmD Drill</p>	<p>4(S) TSV44G*** 4.4 mmD Drill</p>	<p>4(E,D) TSV51D44G*** 5.1/4.4 mmD Drill</p>
	Extraction	■	■	■	
Soft	■	■	■	■ ■ ■	
Dense	■	■	■		■

*** TSV44G and TSV51D44G are not included in the TSVKIT or TSVKITG and must be purchased separately.
TSV51D44G with or without color-coding, or the Original Driva Drill 5.1/4.4 mmD TSV5.1DN may be used as the final drill in dense bone.

6.0 mmD TSX Implant (4.5 mmD Platform)					
<p>Restorative Platform</p> <p>4.5 mmD</p>	<p>1 TSV23G 2.3 mmD Drill</p>	<p>2 TSV34D28G 3.4/2.8 mmD Drill</p>	<p>3 TSV44D38G 4.4/3.8 mmD Drill</p>	<p>4(S) TSV51G 5.1 mmD Drill</p>	<p>4(E,D) TSV57D51G**** 5.7/5.1 mmD Drill</p>
	Extraction	■	■	■	
Soft	■	■	■	■ ■ ■ ■	
Dense****	■	■	■		■

****In dense bone, an optional additional step drill may be used before TSV57D51G: TSV51D44G or TSV5.1DN. Note this additional drill is sold separately and is not included in the TSVKIT or TSVKITG surgical kits and is also the final drill in the dense bone sequence for the 5.4 mmD TSX Implant.

TSX Drilling Sequence - Dríva Drills (Original)

The TSX Implant offers drilling sequences for extraction, soft, and dense bone placement. The final drill in the tested sequence is indicated by an E (extraction), S (soft bone) or D (dense bone). Note: TSX immediate extraction placement drilling protocols were designed and tested by engaging the apical 4 mm of the TSX Implant in dense bone block. Thorough anatomical, bone quality, and bone quantity assessments and surgical planning must be conducted before utilizing this or any surgical drilling protocol. The selection of drilling sequence, placement positioning, and loading protocols are at the discretion of the clinician. For additional information, please consult the Instructions for Use at labeling.zimvie.com.

3.1 mmD TSX Implants

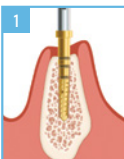
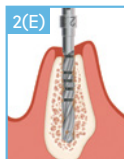
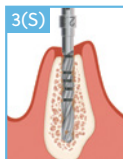
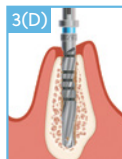
 Restorative Platform 2.9 mmD	 1 020IDSN 2.1/1.6 mmD, 8.0 mmL - 11.5 mmL Drill	 2(E) SV2.3DN 2.3 mmD Drill	 3(S) SV2.4DN 2.4 mmD Drill	 3(D) ZOP28DN 2.8/2.4 mmD Drill
	Extraction* <input checked="" type="checkbox"/>	<input checked="" type="checkbox"/>	<input checked="" type="checkbox"/>	<input type="checkbox"/>
Soft <input type="checkbox"/>	<input type="checkbox"/>	<input type="checkbox"/>	<input checked="" type="checkbox"/>	<input type="checkbox"/>
Dense <input type="checkbox"/>	<input type="checkbox"/>	<input type="checkbox"/>	<input type="checkbox"/>	<input checked="" type="checkbox"/>

NOTE: The top of the laser/score line markings (0.5 mm in height) on the drills are in excess of the length of the implant to be placed by 1.25 mm (8.0 mmL is actually 9.25 mmL). This added length is to accommodate for the design of the drill point. This additional drill length also allows for placement flexibility slightly below the bone crest. The 2.3 mmD Drill is the only drill that is close to the actual implant length (i.e., 8.0 mmL is actually 8.25 mmL).

* When utilizing the 2.3 mmD Drill as the final drill in the 3.1 mmD and 3.7 mmD extraction protocol, take into account the 2.3 mmD drill length as noted above.

3.7 mmD TSX Implant (3.5 mmD Platform)

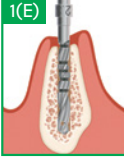
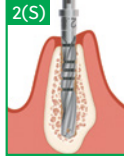
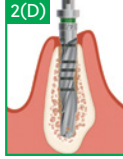
 Restorative Platform 3.5 mmD	 1(E) SV2.3DN 2.3 mmD Drill	 2(S) SV2.8DN 2.8 mmD Drill	 2(D) TSV3DN 3.4/2.8 mmD Drill
	Extraction* <input checked="" type="checkbox"/>	<input checked="" type="checkbox"/>	<input checked="" type="checkbox"/>
Soft <input type="checkbox"/>	<input type="checkbox"/>	<input checked="" type="checkbox"/>	<input checked="" type="checkbox"/>
Dense <input type="checkbox"/>	<input type="checkbox"/>	<input type="checkbox"/>	<input checked="" type="checkbox"/>

4.1 mmD TSX Implant (3.5 mmD Platform)

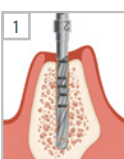
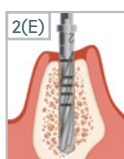
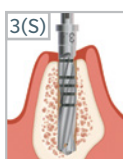
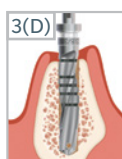
 Restorative Platform 3.5 mmD	 1 SV2.3DN 2.3 mmD Drill	 2(E) SV2.8DN 2.8 mmD Drill	 3(S) SV3.4DN 3.4 mmD Drill	 3(D) TSV3.8DN 3.8/3.4 mmD Drill
	Extraction <input type="checkbox"/>	<input type="checkbox"/>	<input type="checkbox"/>	<input type="checkbox"/>
Soft <input type="checkbox"/>	<input type="checkbox"/>	<input type="checkbox"/>	<input type="checkbox"/>	<input type="checkbox"/>
Dense <input type="checkbox"/>	<input type="checkbox"/>	<input type="checkbox"/>	<input type="checkbox"/>	<input type="checkbox"/>



Long drills shown. Short drills are also available.

4.7 mmD TSX Implant (3.5 mmD Platform)

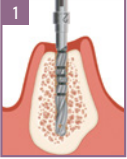
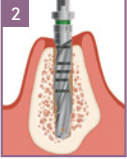

Restorative Platform

3.5 mmD

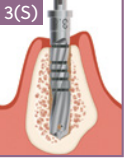
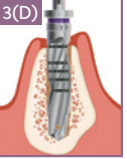
1	2	3(E)	3(S)	3(D)
				
SV2.3DN 2.3 mmD Drill	TSV3DN 3.4/2.8 mmD Drill	SV3.4DN ** 3.4 mmD Drill	SV3.8DN 3.8 mmD Drill	TSV4DN 4.4/3.8 mmD Drill
Extraction	■	■	■	■
Soft	■	■	■ ■ ■ ■	■
Dense	■	■	■	■

**Note: SV3.4DN is utilized only in the extraction protocol for the 4.7 mmD TSX Implant is not marked with a purple color line on the surgical kit.

5.4 mmD TSX Implant (4.5 mmD Platform)



Restorative Platform

4.5 mmD

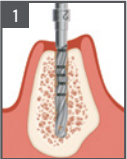
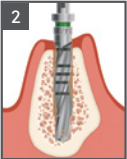
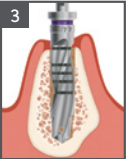
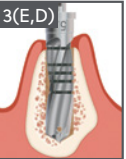
1	2	3	3(E,D)
			
SV2.3DN 2.3 mmD Drill	TSV3DN 3.4/2.8 mmD Drill	TSV4DN 4.4/3.8 mmD Drill	TSV5.1DN 5.1/4.4 mmD Drill
Extraction	■	■	■
Soft***	N/A	N/A	N/A
Dense	■	■	■

***Note there is no soft bone drill in the original Driva Drill offering for the 5.4mm TSX Implant. TSV44G or TSV44SG is the soft bone final drill for 5.4 mm TSX Implants, available as Driva Gold Series Drills.

6.0 mmD TSX Implant (4.5 mmD Platform)



Restorative Platform

4.5 mmD

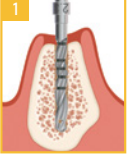
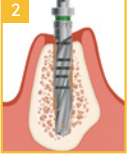
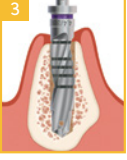
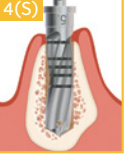
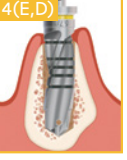
1	2	3	4(S)	4(E,D)
				
SV2.3DN 2.3 mmD Drill	TSV3DN 3.4/2.8 mmD Drill	TSV4DN 4.4/3.8 mmD Drill	SV5.1DN 5.1 mmD Drill	TSV6DN**** 5.7/5.1 mmD Drill
Extraction	■	■	■	■
Soft	■	■	■ ■ ■ ■	■
Dense****	■	■	■	■

****In dense bone, an optional additional step drill may be used before TSV6DN: TSV51DN. Note this additional drill is sold separately and is not included the TSVKIT or TSVKITG surgical kit and is the final drill in the dense bone sequence for the 5.4 mmD TSX Implant.

Fully Guided RealGUIDE Z3D Kit

For information on fully guided surgery solutions for TSX Implants, visit zimvie.com. For guided surgery technique information utilizing the partially-guided Guided Surgery Drill Module and Tube Adapters, see pages 25-26 and 41-45.

These protocols may be generated by RealGUIDE Software when the case is treatment planned and the surgical guide is designed using the GUIDE module of the software.

The TSX fully guided protocols may be generated by RealGUIDE Software when the case is treatment planned and the surgical guide is designed using the GUIDE module of the software.



Partially Guided Surgery Instrumentation

Dríva Drills (Gold Series or original 16 mmL and 22 mmL with black axial stripe on shank) and the Guided Surgery Drill Module with additional length Dríva EG Drills (19 mmL and 25 mmL) are required to interface with surgical guides and provide depth control. Please note that when utilizing the Guided Surgery Drill Module in conjunction with the TSV Surgical Kit, all four lengths of Dríva drills are required to perform Guided Surgery procedures. Follow the surgical protocol provided by your guide manufacturer.

Guided Surgery Module in TSV Surgical Kit

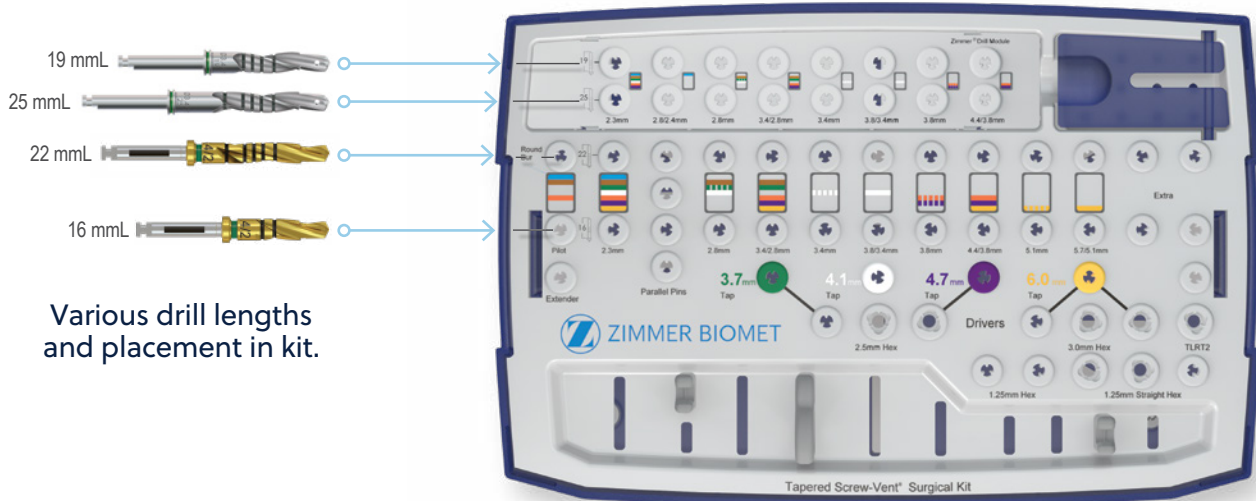

Various drill lengths and placement in kit.

Guided Surgery Module

The Guided Surgery Drill Module with Dríva EG Drills can be easily inserted into the TSV Surgical Kit to accommodate both traditional and guided procedures.



* Guided Surgery Instrumentation includes the Tapered Screw-Vent Instrument Kit, Tube Adapter Kit, and Drill Module with additional length Dríva EG Drills (designed to interface with selected surgical guides). All products sold separately.

Tube Adapter Kit

Tube Adapters fit in the tubes located inside the surgical guide to orient drills and provide positional and angulation control. Use Tube Adapter Diameter A when preparing the osteotomy for 3.7 mm diameter implants, and Tube Adapter Diameter B when preparing the osteotomy for 4.1 mm or 4.7 mm diameter implants. Tube Adapters may be used on the right or left side of the patient's oral cavity as both ends of each Adapter have identical-diameter holes.

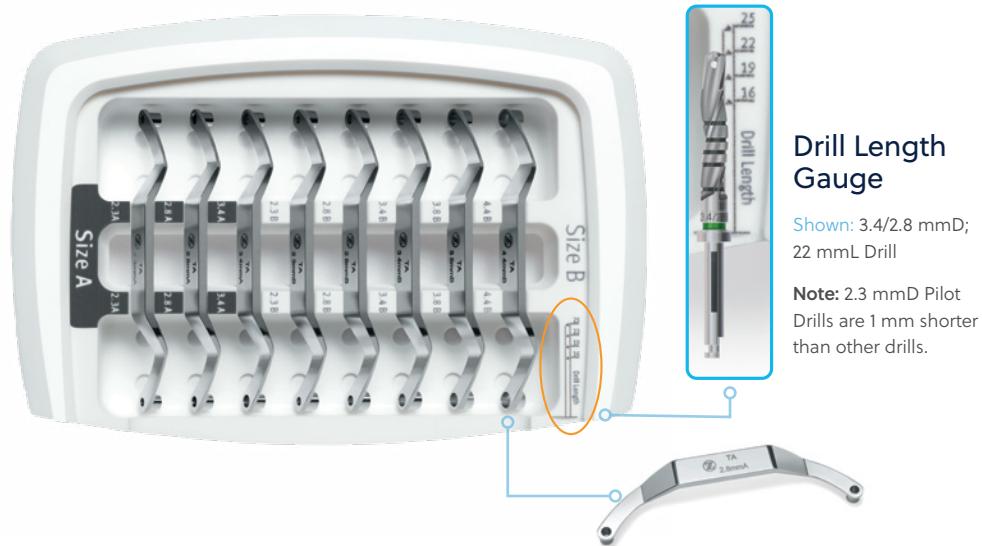

Drill Stop Kit

The Drill Stops are used to limit drilling depth from bone level during osteotomy preparation for TSX Implants. The Drill Stops are made from Grade 5 titanium alloy.

Each Drill Stop Kit row is organized by length of implant being placed. Engraved on the Drill Stops are implant length indications. Indications followed by "L" correspond to the Driva Drill (Gold Series or original), 22 mm. Indications followed by "S" correspond to the Driva Drill, 16 mm. Each Drill Stop Kit column is organized by drill diameter. The Drill Stops are color-coded to correlate with drill diameters.



Drill Stop Kit Instructions

Driva Drill Compatibility

The Drill Stops are designed for use with Driva Drills that have a black axial stripe (16 mmL and 22 mmL).

NOTE: Drill Stops in the last three rows of the first column labeled with implant diameter "2.3" for use with 16 mm Drills are also compatible with the [0201DSN or 0201G] 2.1 mm/1.6 mmD Tapered Pilot Drill for limiting drilling depth to 8.0, 10.0 and 11.5 mm.



0201G or 0201DSN

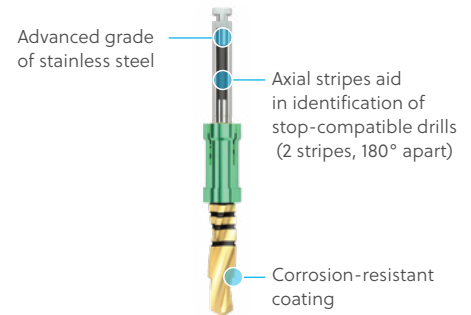

Selecting a Drill Stop

Sample Sequence – Osteotomy for a 3.7 mmD x 13 mmL TSX Implant, using a 22 mmL Driva Drill.

Step 1: From the 13 mmL implant row, select the stop for a 2.3 mmD Pilot Drill.

Step 2: From the same row, select the stop for a 2.8 mmD drill (final for soft bone) or skip to the stop for a 3.4/2.8 mmD Step Drill (final for dense bone).



Placing the Drill Stop on the Drill

Insert the drill tip into the appropriate Drill Stop located in the Drill Stop Kit until firmly seated. Withdraw the drill with the Drill Stop on the drill.



Verifying the Drilling Depth

Verify the drilling depth with the assembled Drill Stop by using the Drill Depth Guide.

NOTE: The top of the laser/score line markings (0.5 mm in height) on the drills are in excess of the length of the implant to be placed by 1.25 mm (8.0 mmL is actually 9.25 mmL). This added length is to accommodate for the design of the drill point. This additional drill length also allows for placement flexibility slightly below the bone crest. The 2.3 mmD Drill is the only drill that is close to the actual implant length (i.e., 8.0 mmL is actually 8.25 mmL).

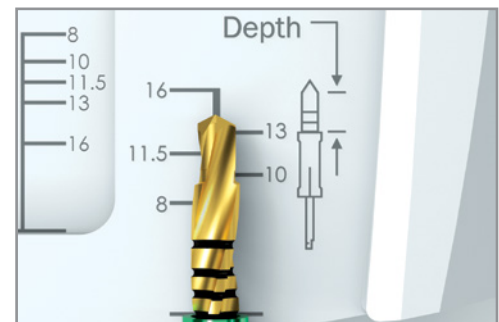

Creating the Osteotomy

Create the osteotomy to the pre-determined depth.

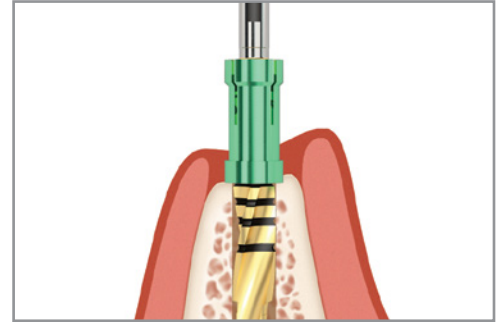

Removing the Drill Stop from the Drill

Disengage the Drill Stop using the Multi-Tool or by hand. Store used stops in the storage bowl.

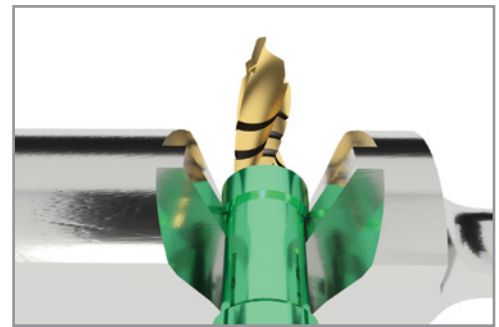

Replacing the Drill Stop in the Kit

Following cleaning, and before placing the drill stop back in the kit, verify the Drill Stop's location in the kit by using the Drill Stop Guide.

NOTE: Replacement Drill Stops are available in case of loss or wear.

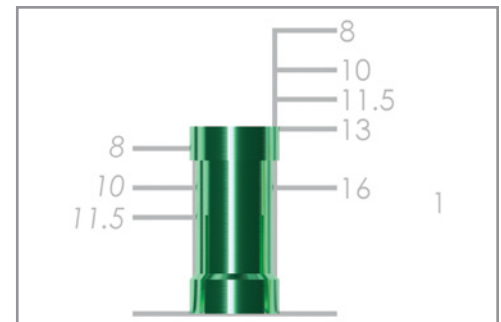

Surgical Procedures



General Surgical Instructions

Cleaning and Sterilization Guidelines

For detailed cleaning and sterilization instructions, please refer to the Instructions for Use (IFU) for each product. Newer Driva Gold Series Drills and Kits with part numbers ending in the letter G utilize IFU "Cleaning and Sterilization of Biomet 3i Kits and Instruments" (P-ZBDINSTRP) available at labeling.zimvie.com.

NOTE: Driva Gold Series Drills and Kits have also been validated to the cleaning and sterilization guidelines for the original Driva Drills and Kits available at labeling.zimvie.com.



Surgical instruments are reusable up to 15 uses, excluding those labeled as single use. Surgical instruments are susceptible to damage and wear and should be inspected before use. The number of uses per drill will vary and depends on a variety of factors including bone density encountered, proper handling, and cleaning. Over time, repeat sterilizations may affect cutting efficiency and color appearance. Cutting edges should present a continuous edge and appear sharp. Check the latch-lock shank for wear to ensure the connection is not damaged. If inspection reveals signs of wear, damage, or unrecognizable color identification, replace the drill accordingly. Please consult the Reusable Instrument Lifespan Manual [[ZBINST0043](#)] for additional information.

Making the Initial Incision

Make a mesiodistal incision along the alveolar crest through the mucoperiosteum and attached gingiva to the bone.

Flap and incision designs may vary due to clinician preference. Flapless surgery is only recommended when adequate bone quantity and quality have been established through appropriate diagnostic procedures.



Exposing the Implant Site

The incision should be long enough to permit adequate reflection and a broad field of view without tearing the tissue. Occasionally, vertical releasing incisions may be employed.

Using a periosteal elevator, carefully lift the periosteum to expose the alveolar bone only as necessary to provide an adequate surgical working area.

Place retractors or sutures to hold the soft tissues.

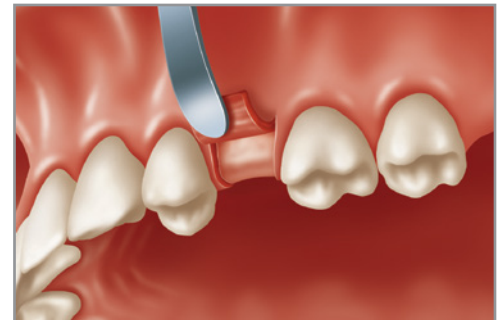

Removing Bone Irregularities and Assessing Implant Site

Remove any spinous ridges or other bone irregularities using the optional Round (Rosette) Bur [1203G or 1203], Tapered Pilot Drill [0201G or 02021DSN], or a Rongeur Forcep. Keep bone removal to a minimum. Insufficient bone height/width and abnormal defects or contours not previously detected may now contraindicate placement of the implant.

Maintain previously discussed requirements for ridge width and implant requirements.

Ridge contour should be adequately palpated to estimate an angle of insertion which will achieve parallelism with other implants and natural tooth abutments where indicated.



Using the Drill Extension

Use the drill extension when additional length is required due to interference caused by adjacent teeth. The Drill Extender [DEG or DE] extends the length of the drill.

The drill extension has a standard latch-lock shank with a cylindrical shaft to accommodate the latch-lock type drill into the extension.

Do not use with drills other than the standard latch-lock type or exceed speeds of 850 rpm with the drill extension.



Marking the Implant Site

Seat the surgical guide in place to assist in marking the implant sites, and to help with the inclination as well as spacing of the implant sites relative to the proposed restoration.

Use copious external irrigation with the Round (Rosette) Bur [1203G or 1203] and create a dimple through the dense ridge crest in the area of each proposed implant site. The dimple helps to prevent the surgical drills from drifting (chattering) from the proposed drill site.

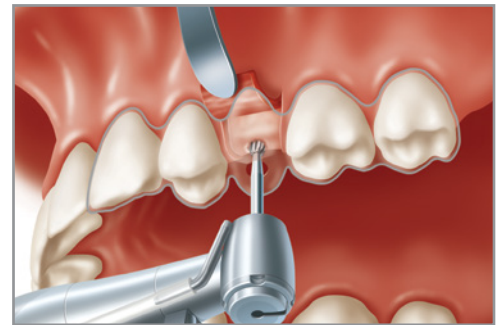

Using the Surgical Drills

Reusable drills are designed to be used with both internal and external irrigation with a surgical unit that can supply a range of drilling speeds from 15-2000 rpm with sufficient torque. A recommended range for drilling is between 600-850 rpm, although clinicians may vary from this range in their protocol.

NOTE: The top of the laser/score line markings (0.5 mm in height) on the drills are in excess of the length of implant to be placed by 1.25 mm (8.0 mmL is actually 9.25 mmL). This added length is to accommodate for the design of the drill point and also allows for flexibility in implant placement depth to be either crestal or slightly subcrestal. The 2.3 mmD Pilot Drill [TSV23G, TSV23SG or SV2.3DN, SV2.3DSN] is the only drill that is close to the actual length (i.e., 8.0 mmL is actually 8.25 mmL).

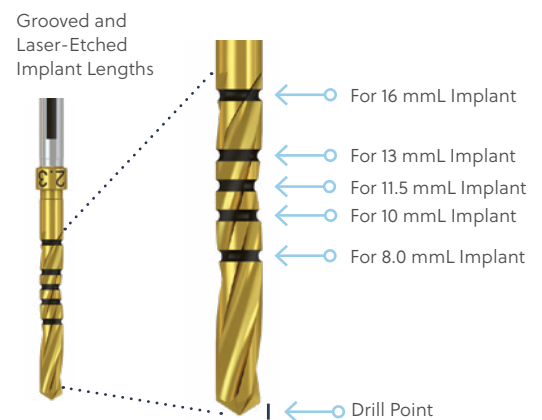

Using the Surgical Drills with Drill Stops

The Drill Stops in the Drill Stop Kit are used to limit drilling depth from bone level. Drill stop compatible drills are marked with black axial stripes. To place the Drill Stop on the drill, insert the drill tip into the appropriate Drill Stop located in the Drill Stop Kit until firmly seated. Withdraw the drill with the Drill Stop in place. Verify the drilling depth using the Drill Depth Guide on the kit. For additional information on the Drill Stop Kit, see pages 26-28.



Initiating the Osteotomy

Perform all drill procedures with a straight up-and-down motion in order to avoid creation of an oval-shaped osteotomy. This pumping action in combination with copious irrigation will also help to minimize excessive heat generation and preserve the vitality of bone. The system should deliver an adequate flow of irrigation (40-100 ml/min) for a cooling, low-trauma surgical procedure.

NOTE: Use the hand piece designed for surgical motors only. This will ensure that compressed coolant air is not introduced to the surgical site.

For 3.7 mmD through 6.0 mmD TSX Implants, use the 2.3 mmD Drill to create a pilot hole to the depth of the implant to be used. Note that the Tapered Pilot Drill [0201G or 0201DSN] is the first drill in the preparation sequence for the 3.1 mmD implant, followed by the 2.3 mmD Drill. Flush the hole to remove all debris.

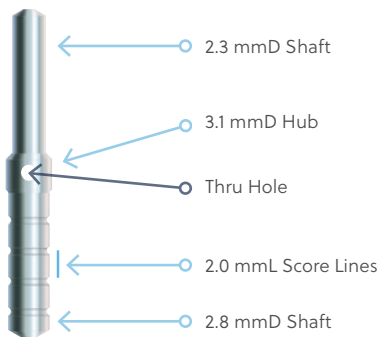
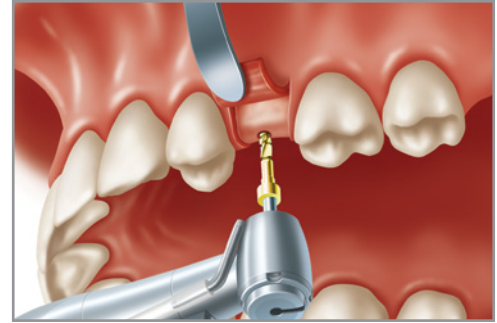

Using the Paralleling Pin

The Paralleling Pin [PPAR] is designed with opposing ends having two diameters, 2.3 mmD and 2.8 mmD. This enables the clinician to use the pins in the first two steps of the drilling sequence to ensure correct placement and alignment of the implants.

Larger diameter drills should follow the path created by the 2.3 mmD and 2.8 mmD drills.

The 2.0 mmL score lines on the 2.8 mmD side of the Paralleling Pin can supply the clinician with an indication of height available for the restorative aspect of the procedure.

Inserting the Paralleling Pin

Thread floss through the hole in the middle of the pin for retention to prevent patient aspiration.

Insert the smooth side of the Paralleling Pin into the first 2.3 mmD osteotomy and confirm placement and alignment relative to the surgical guide.

Use the first pin as a guide and continue to drill the required sites to 2.3 mm diameter, inserting pins in each of the holes after they have been drilled and flushed to remove the debris.

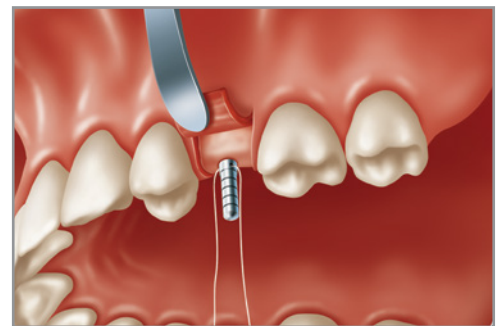

Drilling the Osteotomy

Utilize the next drill in the drilling sequence for the implant diameter being placed to create an intermediate hole to the depth of the implant to be used. Utilize the 2.8 mmD side of the Parallel Pin when appropriate.

NOTE: Due to the density of bone commonly found in the symphysis region, newer, sharp drills are recommended. Clean drill heads often to remove debris and ensure a sharp cutting surface. For irrigated drills only: NM1940 cleaning wire is no longer manufactured or available. A 25-gauge needle can be used to clean the drill's irrigation hole. Note, a 30-gauge needle is required for drills that are 2.8 mmD or narrower.

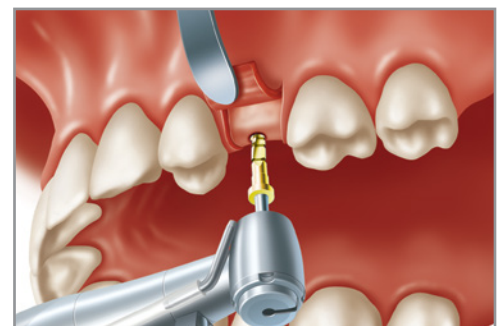

Intermediate and Final Sizing of Osteotomies

Continue widening the osteotomy by following the appropriate drilling sequence for the implant diameter being placed (extraction, soft or dense) prior to selection of the final drill. (See drilling sequences on pages 21 - 24).

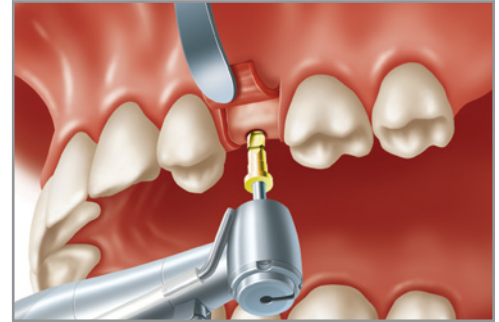

Straight Drill for Soft Bone

Use the straight intermediate drills as the final drill when placing implants into soft bone according to the appropriate drilling sequence for the implant diameter being placed. (See drilling sequences on pages 21 - 24) and additional information regarding soft- and dense-bone protocols on pages 7 and 34.

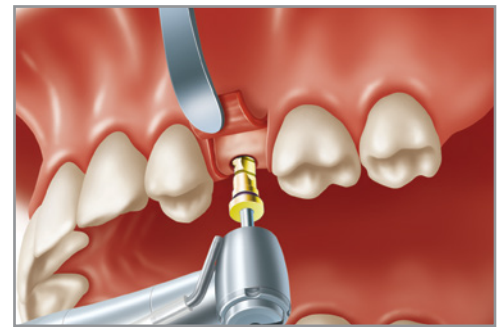

Stepped Drills for Dense Bone

Stepped drills for final sizing of the osteotomy are available when placing tapered implants in dense bone according to the appropriate drilling sequence for the implant diameter being placed (see drilling sequences on pages 21 - 24). These drills are designed to accommodate the varying lengths of tapered implants without having to have length-specific tapered drills. The drill has two diameters of straight-walled design incorporated into one drill. This is designed to allow the implants to obtain maximum engagement into bone no matter the length of implant being used.

The length of the stepped area is approximately 5.0 mm from the point of the drill to the start of the wider portion. The stepped drills have color-coded bands based on implant color coding. (See color-coding charts on page 16).

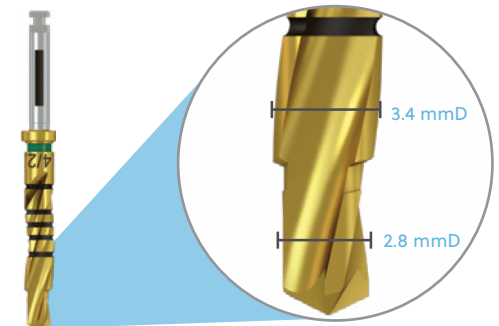

NOTE: Taps are not included in the TSX Implant drilling sequence. The TSV and Eztetic taps are NOT compatible with the TSX Implant due to the differing thread pattern. For TSX Implants in dense bone, follow the TSX dense bone protocol as shown on 21 - 24.

Preparing for Implant Placement

Irrigate the implant sites with sterile water and then suction prior to implant placement, ensuring no debris is left at the base or attached to the vertical walls of the osteotomy.

Any debris could hinder the vertical placement of the implant as well as possibly increase the insertion torque above acceptable limits.

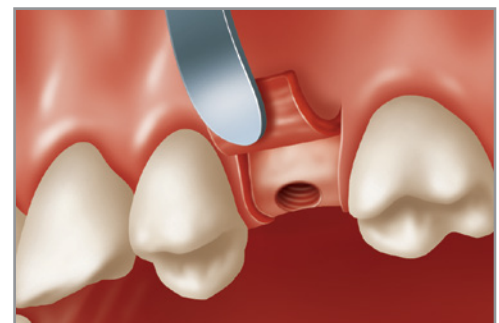

Soft- and Dense-Bone Protocols

Final Sizing of Osteotomy

Drill the osteotomy according to the density of the bone surrounding the proposed implant site. In addition, an extraction protocol is available.

In areas where the bone is commonly referred to as soft bone, it is often advocated to stop the drilling sequence at the straight drill before the final step drill.

Please refer to drilling sequences on pages 21 to 24.



Placing Implant into Osteotomy

Soft-bone protocol: From time of initial placement of the implant in the straight hole, the implant will start to compress the bone. This occurs due to the fact that the hole size is slightly smaller than the apex size of the implant. Example: Using the 4.1 mmD implant with a 3.7 mmD apex and inserting into a hole with a 3.4 mmD opening.

Dense-bone protocol: From time of initial placement of the implant in the stepped hole, the implant will drop almost a third of its length before stopping. This occurs because the hole size is bigger than the apex size of the implant. Example: Using the 4.1 mmD implant with a 3.7 mmD apex and inserting into a 3.8 mmD opening.



Placing Implant into Osteotomy, Close Up

Soft-bone protocol: Compression of bone occurring from time of initial insertion.

Dense-bone protocol: Implant drops into hole partially at time of initial insertion.

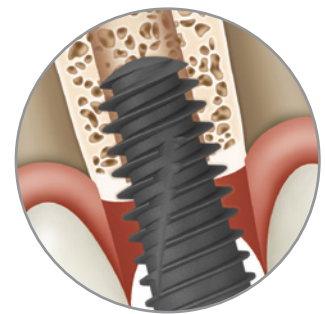

Completing Placement of Implant

Soft-bone protocol: Compression of bone occurring the full length of the implant, improving initial stability from time of placement.

Dense-bone protocol: As the implant progresses, the thread will engage the walls of the osteotomy.



Immediate Extraction Placement

Final Sizing of Osteotomy

Drill the osteotomy according to the extraction protocol, taking care to drill the osteotomy in the intended final implant location. Please refer to drilling sequences on pages 21 to 24 and Anatomical Criteria on pages 5 and 6. TSX immediate extraction placement drilling protocols were designed and tested by engaging the apical 4 mm of the TSX Implant in dense bone block. Additional preparation may be necessary. Thorough anatomical, bone quality, and bone quantity assessments and surgical planning must be conducted before utilizing this or any surgical drilling protocol. The selection of drilling sequence, placement positioning, and loading protocols are at the discretion of the clinician. For additional information, please consult the Instructions for Use at labeling.zimvie.com.

Placing Implant into Single-Rooted Sites

In single-rooted extraction sites, drill the osteotomy beyond the apex of the original tooth root in the intended implant location, taking into account the desired bone engagement and anatomical limitations. Place the implant into the prepared osteotomy and graft gaps in the residual defect as necessary.

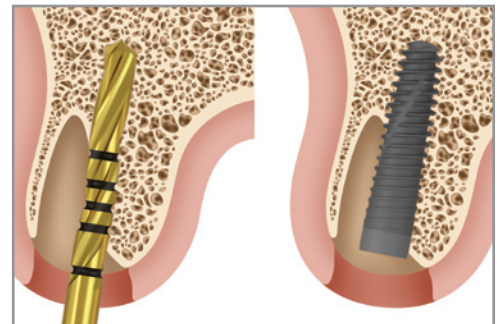

Placing Implant into Multi-Rooted Sites

In multi-rooted extraction sites, drill the osteotomy in the intended final implant location beyond the apices of the original tooth roots, taking into account the desired bone engagement and anatomical limitations. Place the implant into the prepared osteotomy and graft gaps in the residual defect as necessary.

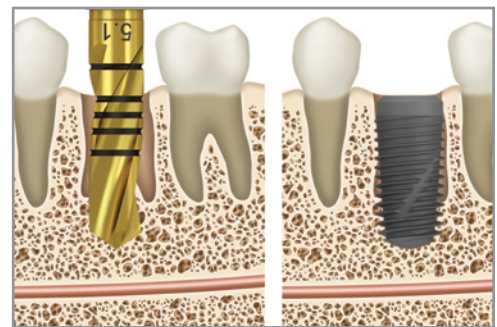

Implant Placement

Removing the Implant from the Vial

Remove the implant outer vial from the box and open the outer vial to break the seal. Drop the sterile inner vial and contents onto a sterile field or place into a sterile Staging Block. Flip the top of the inner vial open. Press the top to the inner vial body to lock in the top. Remove the alignment pin with a clean gloved hand and set into the sterile field. For further instructions see the Packaging Instructions on pages 13-15.

Remove the implant from the inner vial by using one of the delivery instruments (see the next section).







NOTE: The supplied Surgical Cover Screw is located in the lid of the inner vial with an access hole for the 1.25 mmD GemLock Hex Tool.



Delivering the Implant to the Site

The implant may be driven manually or with the use of a surgical motor at speeds up to 30 RPM. The 2.1 mmD Drivers are utilized with the 3.1 mmD TSX Implant. The 2.5 mmD drivers are utilized with larger TSX Implant diameters.





For manual placement, engage the 2.1 mmD GemLock Drivers [CHR2.1, CHRL2.1] or 2.5 mmD GemLock Drivers [GHX2.5, GHX2.5L, RH2.5 or RHL2.5] into the Z-High Torque Indicating Ratchet Wrench [ZTIRW*]. Insert the Driver directly into the implant to engage, lift it from the inner vial, and deliver it to the surgical site. For alternative manual implant placement instrumentation, the GemLock Ratchet [RSR] or Screwdriver Handle [SSHS] may be attached to the Drivers.

Manual Insertion					
Manual Insertion Tools		2.1 mmD Manual Drivers (for 3.1 mmD TSX Implants)		2.5 mmD Manual Drivers (for 3.7 – 6.0 mmD TSX Implants)	
ZTIRW*		CHR2.1		GHX2.5 or RH2.5	
RSR		CHRL2.1		GHX2.5L or RHL2.5	
SSHS					



***NOTE:** Do not exceed 90 Ncm when pulling on the torque-indicating arm of ZTIRW. If high insertion torque during implant placement is anticipated and torque indication is desired, additional preparation is required to reduce insertion torque to 90 Ncm or below. Alternatively, the ZTIRW body, without pulling on torque-indicating arm, may be used as a traditional ratchet wrench without torque indication and is designed to withstand regular use in this manner up to 150 Ncm. Usage above 150 Ncm may cause accelerated wear.

For placement with a motor handpiece set up to 30 RPM, insert the 2.1 mmD GemLock Latchlock Driver [CHD2.1, CHDL2.1] or 2.5 mmD GemLock Latchlock Driver [GHX2.5D, RHD2.5 or GHX2.5DL] into the motor handpiece. Insert the Latchlock Driver into the implant to engage, lift it from the inner vial, and deliver it to the surgical site. Switch to manual method to complete insertion as desired or required.

Surgical Motor Insertion			
2.1 mmD Latchlock Drivers (for 3.1 mmD TSX Implants)		2.5 mmD Latchlock Drivers with Gemlock Retention (for 3.7 – 6.0 mmD TSX Implants)	
CHD2.1		GHX2.5D or RHD2.5	
CHDL2.1		GHX2.5DL	

NOTE: Do not exceed 80 Ncm of torque when using the Latchlock Gemlock Drivers [GHX2.5D, GHX2.5DL and RHD2.5].

Inserting and Orienting the Implant

Gently seat the implant into the osteotomy. Thread the implant into the prepared site using tools described above. TSX Implants are designed to be placed at or slightly below crestal bone level.

To ensure proper orientation of the Hex-Lock Contour and Angled Abutments, align a hex flat on the driver tool buccal aspect. When utilizing driver tools without hex indication, to confirm alignment, remove the driver tool and visually check the hex orientation of the hexagonal driver tip in relation to the implant or visually inspect the implant internal hex.

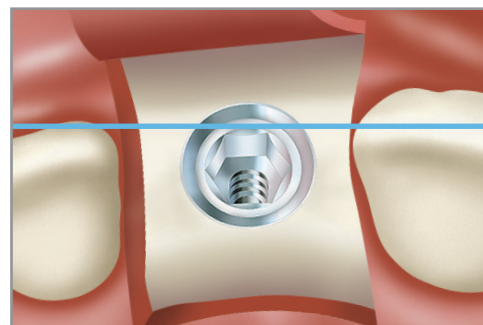

After the implant is seated in the desired position, irrigate the surgical site with sterile water and then suction, ensuring the implant's internal chamber is clear of bone and tissue debris and/or blood. This procedure will allow for the unimpeded seating of the optional Alignment Pin, Surgical Cover Screw, Healing Collar, or Provisional Abutment.

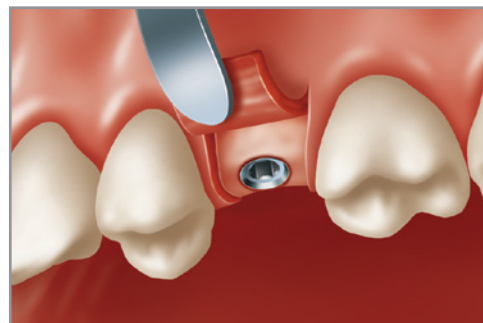

Optional Alignment Pin

TSX Implant Packaging includes an optional, single use Alignment Pin designed to guide implant parallelism when placing multiple implants. The Alignment Pin is to be placed in the sterile field during implant placement. To utilize, pick up the Alignment Pin by a clean gloved hand from the sterile field. Thread floss through the hole in the middle of the pin for retention to prevent patient aspiration. Screw the threaded end clockwise into the implant's internal connection threads. Hand tighten only. The Alignment Pin may remain in place while multiple implants are seated to guide parallelism. After all implants are placed, remove the Alignment Pins in a counterclockwise fashion and discard. Repeat irrigation of the surgical site with sterile water and then suction, ensuring the the implant's internal chamber is clear of bone and tissue debris and/or blood. This procedure will allow for the unimpeded seating of the Surgical Cover Screw, Healing Collar, or Provisional Abutment.

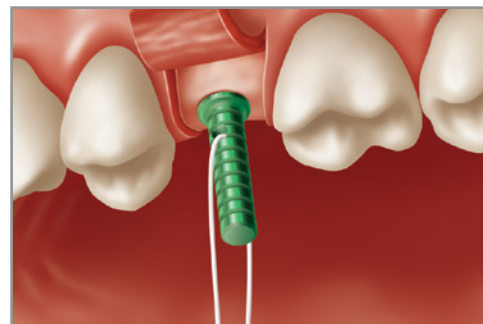

Two-Stage and One-Stage Protocols

Surgical Options: Two-Stage or One-Stage Healing

In a traditional two-stage protocol, the surgical cover screw is threaded into the implant over which the tissue is sutured during implant healing. To select the surgical cover screw, unthread the surgical cover screw from its plastic mount in the lid of the inner implant vial. Use the 1.25 mmD Hex Driver with GemLock retention [HXGR1.25, HXLGR1.25] to engage the surgical cover screw through the access hole. Press the Hex Driver to the side to open the white flap of the lid and retrieve the surgical cover screw. Continue with the following steps on this page.

For a one-stage procedure, depending on initial implant stability and the overall treatment plan, a healing collar or provisional abutment is placed around which the tissue is sutured. (See page 46 for information on Bone Profilers. See page 48 for Healing Collar Selection Guidelines).

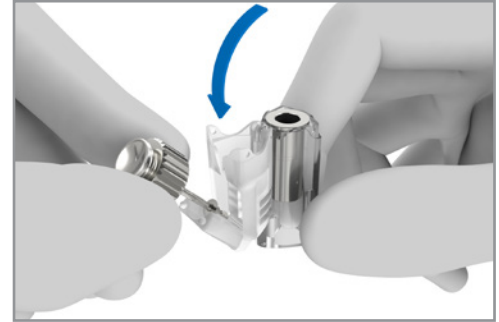

Two-Stage: Placing the Surgical Cover Screw

Use the 1.25 mmD Hex Driver with retentive GemLock feature [HXGR1.25, HXLGR1.25] to carry the Surgical Cover Screw to the opening of the implant. Gently thread the screw into the implant ensuring proper thread engagement between the two components.

Tighten using finger pressure only. The Surgical Cover Screw should fit flush with the top of the implant. This will provide a low profile, often level with the crest of the ridge. This low profile is advantageous when primary soft-tissue closure is desired.

After placement of the implant and Surgical Cover Screw, take a radiograph to confirm position before closure of the soft tissue.

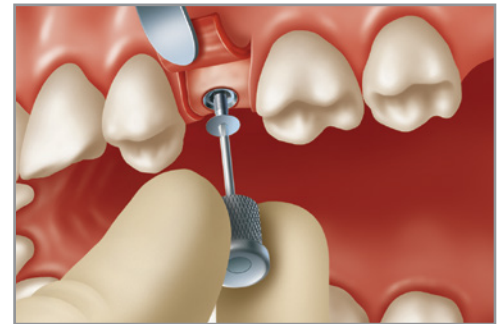

Two-Stage: Suturing the Soft-Tissue

Carefully replace the soft tissue over the Surgical Cover Screws. Use suture material of choice and suture with one or more of the suture methodologies available (interrupted sutures shown).

Instruct the patient to follow post surgical maintenance and hygiene. Provide a provisional prosthesis that is designed to prevent any premature loading on the implants.

Remove the sutures after 1 to 2 weeks.

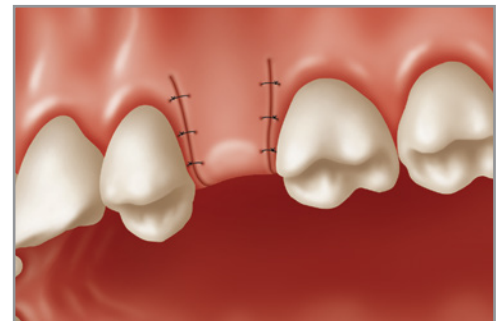

Two-Stage: Removing the Provisional Prosthesis

Through x-ray analysis and knowledge of bone density in the surgical area, determine the time for second-stage surgical procedures.

Remove the provisional prosthesis.

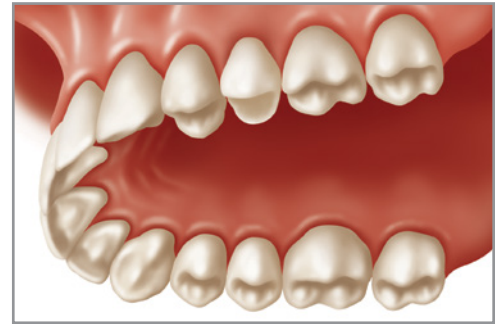

Two-Stage: Locating the Surgical Cover Screw

Locate the position of the Surgical Cover Screw by palpation of the soft tissue or with the use of a periodontal probe.

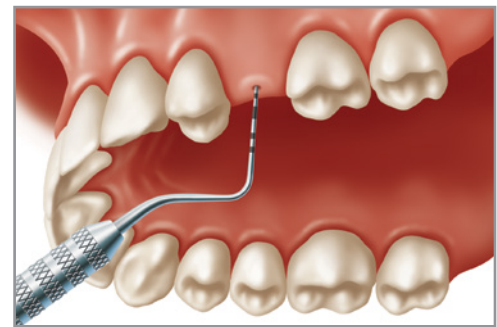

Two-Stage: Exposing the Surgical Cover Screw

Expose the Surgical Cover Screw by using a Tissue Punch or a scalpel.

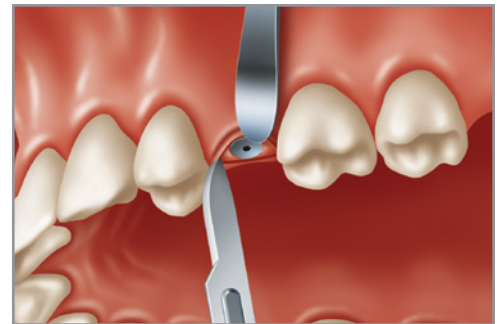

Two-Stage: Removing the Surgical Cover Screw

Remove any bone growth from the superior aspect of the Surgical Cover Screw. Care must be taken not to damage the implant during the process of bone removal.

Use the 1.25 mmD Hex Driver with GemLock retention [[HXGR1.25](#), [HXLGR1.25](#)] in a counter-clockwise direction to remove the Surgical Cover Screw.

The implant can now be evaluated to determine if it is sufficiently anchored in the surrounding bone.

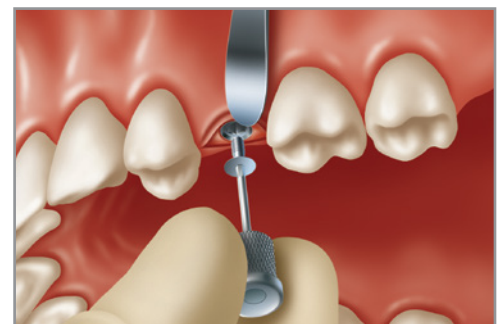

One-Stage or Two-Stage: Seating the Healing Collar

See page 46 for information of Bone Profilers. Irrigate the surgical site with sterile water and then suction, ensuring the implant's internal chamber is clear of bone and tissue debris and/or blood. This procedure will allow for the unimpeded seating of the Healing Collar and complete closure of the implant's internal chamber and prosthetic interface.

See page 48 for Healing Collar Selection Guidelines. Thread the Healing Collar into the implants with a 1.25 mmD Hex Driver with GemLock retention [HXGR1.25, HXLGR1.25] and then use finger pressure to tighten.

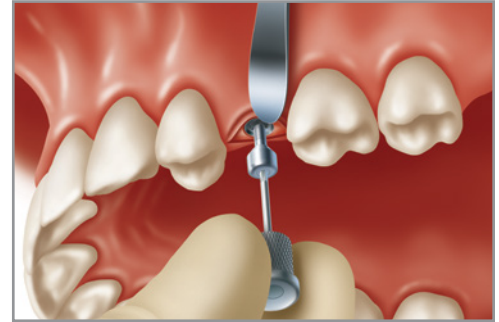

One-Stage or Two-Stage: Suturing the Soft-Tissue

Carefully replace the soft tissue around the Healing Collar. Use suture material of choice and suture with one or more of the suture methodologies available (interrupted sutures shown).

Instruct the patient to follow post surgical maintenance and hygiene. Provide a provisional prosthesis that is designed to prevent any unguided loading on individual implants (i.e., the occlusal load is shared with all implants and/or surrounding dentition equally).

Remove the sutures after 1 to 2 weeks.

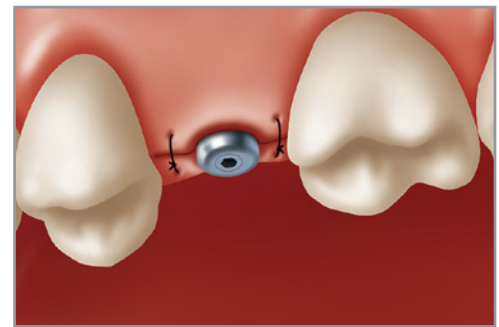

One-Stage or Two-Stage: Removing the Healing Collars

In a two-stage procedure, use the 1.25 mmD Hex Driver with GemLock retention [HXGR1.25, HXLGR1.25] to remove the Healing Collars after a satisfactory soft-tissue healing period, to be determined on a case by case basis.

If a one-stage protocol was utilized, remove the Healing Collar (or immediate provisional restoration) after the appropriate implant healing period.

The implants are now ready for the restorative phase of the implant procedure.

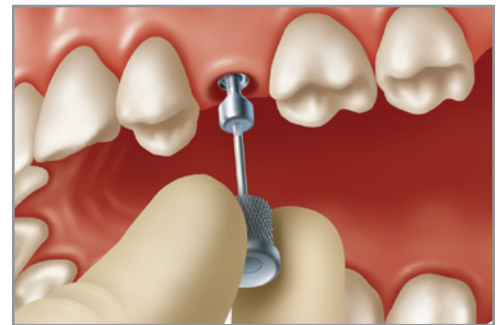

One-Stage or Two-Stage: Measuring Soft-Tissue Depth

Use a periodontal probe with 1.0 mm demarcation lines to measure the buccolingual and mesiodistal soft-tissue depth. Measurements are taken from the superior aspect of the implant to the gingival margin. Measurements will assist in determining the height of the abutment required for the restoration. Refer to the Trabecular Metal and Tapered Screw-Vent Implant Restorative Manual, for further restorative instructions for TSX Implants.

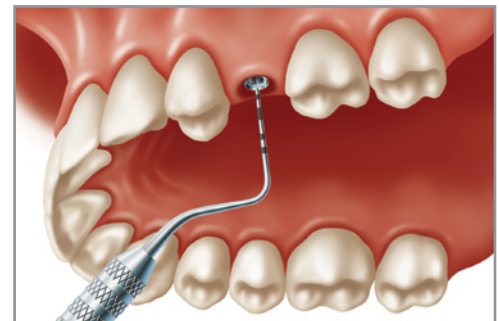

Guided Surgery

Surgical Guide and Protocol

A specialized provider like Implant Concierge or dental laboratory fabricates the case-specific surgical guide compatible with Guided Surgery Instrumentation. The guide manufacturer delivers the surgical guide, along with the surgical protocol for each TSX Implant site preparation.



Surgical Protocol Summary

RealGUIDE software provides automatic drilling protocols and implant mount selection for creating the osteotomy and placing the TSX Implants fully guided using the Z3D kit. Alternatively, the osteotomy can be created using the TSV kit along with the GSMOD and TADKIT add ons.



Surgical Guide Placement

The tooth-, mucosa-, or bone-supported surgical guide is fixed to the surgical site. ZimVie sells fixation pins and pin sleeves that may be utilized for a mucosa-supported guide.

Shown: A tooth-supported surgical guide with elevated flap.

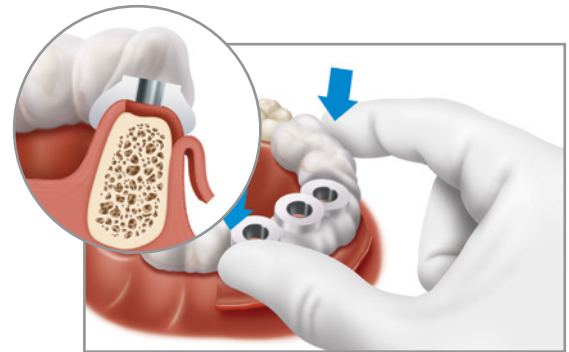

Guided Surgery Instrumentation

The TSX Implant may be placed fully guided with the Z3D RealGUIDE Kit. For more information visit the RealGUIDE Z3D Guided Surgery Kit page on www.zimvie.com. Reference the case specific surgical protocol with the surgical guide. When utilizing the partially-guided surgical kit, follow the sequence of Tube Adapters and Surgical Drills to prepare the implant osteotomy.

The Tube Adapter fits inside the titanium tube insert in the surgical guide. Tube Adapters — used in conjunction with the drills and length-specific surgical guides — provide positional, angulation, and depth control, and are labeled for easy identification. Tube Adapters can be used on the patient's left- or right-hand side as the holes on both sides are identical in diameter.



Guided Surgery Instructions

Treatment Planning

Clinician performs the clinical exam and takes patient records and diagnostics. Overall restorative treatment plan for the desired restorative outcome is developed in conjunction with the implant team typically by using a software like RealGUIDE. If required, patient is referred to the surgical specialist for further evaluation.



Scan Prosthesis

Dental laboratory or clinician fabricates a scan prosthesis — generally a radiopaque duplicate of the provisional teeth set-up or patient's existing denture — for visibility of the desired tooth location in CT images and selected case planning software.



CT Scan

Patient undergoes CT scan (wearing the scan prosthesis), according to the software supplier's general scanning instructions — including patient preparation, positioning, image reconstruction, and scanning parameters.



Surgical Case Planning

The CT scan data is converted into a format that allows it to be utilized by the selected case planning software, or is imported directly. The case is then planned in the treatment planning software.



Sample Surgical Sequence

The following steps detail the surgical sequence for the example case shown in the surgical protocol on page 45: an osteotomy for a 3.7 mmD x 16 mmL TSX Implant in tooth location #23, in dense bone.

Tube Adapter Selection

Following the surgical guide protocol, select the initial Tube Adapter 2.3 A (2.3 mmD; size A) from the Tube Adapter Kit. Place the Tube Adapter into the guide tube on the most convenient side.



Drill Selection

Select the initial drill from the protocol – 2.3 (22 mm), (2.3 mmD; 22 mmL). Verify drill length of 22 mm with the Drill Length Gauge on the Tube Adapter Kit.

Shown: 3.4/2.8 mmD; 22 mmL drill.

NOTE: 2.3 mmD Pilot Drills are 1mm shorter than other drills.



Initiating the Osteotomy

Drill to initiate an osteotomy through the Tube Adapter until the drill flange stops on top of the Tube Adapter. The predetermined drilling depth is achieved by the combination of custom guide height and appropriate drill selection, indicated in the guide manufacturer's protocol.

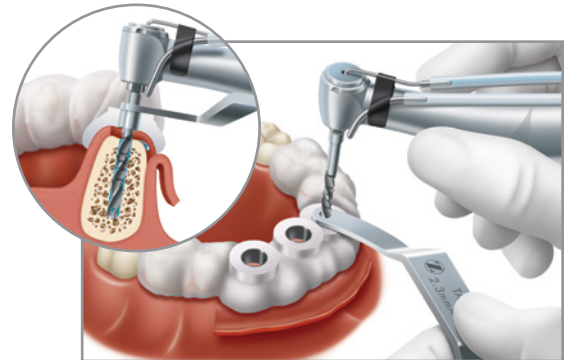

Expanding the Osteotomy

Remove the Tube Adapter 2.3 A and place the next Tube Adapter 2.8 A into the guide tube opening. Use the next drill in the sequence, 2.8 (22 mm), to expand the osteotomy through the Tube Adapter until the drill flange stops on top. Verify drill length of 22 mm with the Drill Length Gauge on the Tube Adapter Kit.

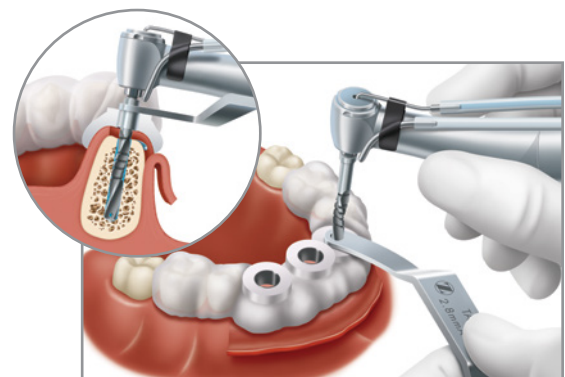

Further Expanding the Osteotomy

Remove the Tube Adapter 2.8 A and place the next Tube Adapter 3.4 A into the guide tube opening. Select the next drill in the sequence, 3.4/2.8 (22 mm). Following Drill length verification with the Drill Length Gauge, expand the osteotomy through the Tube Adapter until the drill flange stops on top.

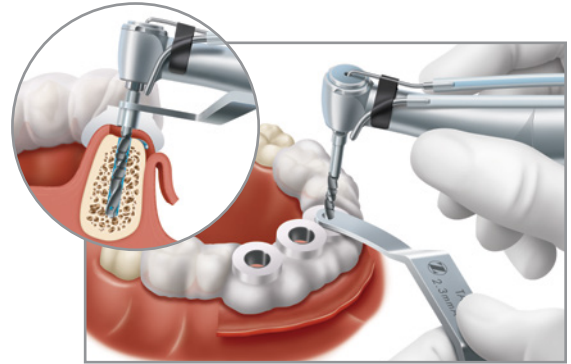

Placing the Implant

Remove the surgical guide and follow standard implant placement guidelines.

NOTE: Guided Surgery System shown does not facilitate fully guided implant placement. For information on fully guided implant placement, consult www.zbguidedsurgery.com on fully guided surgery options.

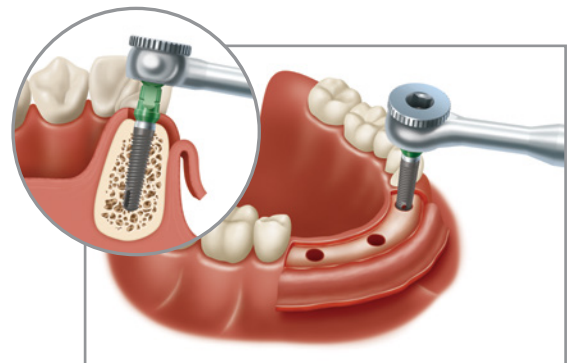

For information on fully guided surgery solutions for TSX Implants, visit the RealGUIDE Z3D Guided Surgery Kit section of www.zimvie.com. For guided surgery technique information utilizing the Guided Surgery Drill Module and Tube Adapters, see pages 42-44.

Select Drills and Tube Adapters following the protocol provided by the surgical guide manufacturer. The predetermined drilling depth is achieved by the combination of custom guide height and appropriate drill length selection, indicated by the guide manufacturer. Drill flange will stop on the top of the Tube Adapter when a desired depth is achieved.

NOTE: Verify drill length with the Drill Length Gauge on the Tube Adapter Kit (See page 26).

Sample Surgical Protocol for TSX Guided Surgery Instrumentation

Example below: Surgical protocol example for a tooth-supported guide - three TSX Implants in mandible (tooth #23, #25, #27).

1	Tooth Number	23	25	27
Implant Information				
2	Implant Part Number	TSX37B16	TSX37B11	TSX47B13
3	Implant Diameter (mm)	3.7	3.7	4.7
4	Implant Length (mm)	16	11.5	13
5	Depth Control	Yes	Yes	Yes
Surgical Sequence				
6	Tube Adapter	2.3 A	2.3 A	2.3 B
7	Drill	2.3 (22 mm)	2.3 (19 mm)	2.3 (19 mm)
8	Tube Adapter	2.8 A	2.8 A	3.4 B
9	Drill	2.8 (22 mm)	2.8 (19 mm)	3.4/2.8 (19 mm)
10	Tube Adapter	3.4 A	3.4 A	3.8 B
11	Drill	3.4/2.8 (22 mm)	3.4/2.8 (19 mm)	3.8 (19 mm)
12	Tube Adapter	•	•	4.4 B
13	Drill	•	•	4.4/3.8 (19 mm)

NOTE: The instrument selection protocol and appearance may differ depending on the case planning software. For detailed information about location of the instruments in the surgical kits, please reference pages 17-20 and 25-26 of this manual. For additional Guided Surgery technique information, please reference the Instructions for Use available at labeling.zimvie.com. For detailed surgical guide instructions for use please contact your software and/or surgical guide manufacturer.

Sample Surgical Protocol for Guided Surgery Instrumentation

Bone Profilers

ZimVie Dental Bone Profilers are used to assist in bone removal around the coronal aspect of the implant allowing for proper seating of healing abutments, prosthetic components, impression copings, and final restorations. This step can be employed in one-stage or in two-stage surgical protocols. It is especially useful for subcrestal implant placement, but can be utilized in select crestally placed implants as needed.



Each Bone Profiler exhibits an ISO-Latch connection design and can be used with:

- A contra-angle handpiece drill for powered use.
- A Low Torque Indicating Ratchet Wrench Standard ISO 1797 Adapter [Item #: C9980] attachment to facilitate manual use.

Important Considerations

Bone Profilers are used to assist in bone removal around the coronal aspect of the implant allowing for proper seating of healing abutments, prosthetic components, impression copings, and final restorations. This step can be employed in one-stage or in two-stage surgical protocol. It is especially useful for subcrestal implant placement but can be utilized in select crestally placed implants as needed.

- The following Bone Profilers are designed to be used with TSX Implants.
- Bone Profilers are provided non-sterile. The Bone Profilers are reusable up to 15 uses and require cleaning and sterilization prior to each use. For recommended cleaning and sterilization instructions, please see the Instructions for Use available at labeling.zimvie.com.
- Bone Profilers should be inspected for wear before each use.
- Recommended Bone Profiler speed is at or below 50 rpm. Exceeding rpm may damage the implant seating surface or internal structure.
- Verify that the Bone Profiler is engaged/retained within the locking mechanism of the drill motor/handpiece, in order to prevent accidental swallowing or aspiration.
- Bone Profiler should be fully seated onto the implant site before use. Activating Bone Profiler prior to seating may damage the implant seating surface or internal structure.

Bone Profilers for Encode® Healing Abutments



Restorative Platform	Emergence Profile	TSV Encode Healing Abutment	TSV/TM Connection
3.5 mm	3.8 mm	TEHA3383/ TEEHA333	BPT3545
		TEHA3385/ TEEHA335	
		TEHA3387/ TEEHA337	
3.5 mm	5.0 mm	TEHA3503/ TEEHA353	BPT3555
		TEHA3505/ TEEHA355	
4.5 mm	5.0 mm	TEHA4503	BPT4555
		TEHA4505	
	5.6 mm	TEHA4563/ TEEHA453	BPT4565
		TEHA4565/ TEEHA455	
		TEHA4567/ TEEHA457	
	6.0 mm	TEHA4603/ TEEHA463	BPT4565
TEHA4605/ TEEHA465			

Bone Profilers for TSX Implants

Restorative Platform	Emergence Profile	Eztetic Connection
2.9 mm	3.7 mm	BPE2937
	4.5 mm	BPE2945



Bone Profilers for TSX Implants

Restorative Platform	Emergence Profile	TSV/TM Connection
3.5 mm	3.5 mm	BPT3535
	4.5 mm	BPT3545
	5.5 mm	BPT3555
4.5 mm	4.5 mm	BPT4545
	5.5 mm	BPT4555
	6.5 mm	BPT4565



Note: Can be used for Tapered Abutments

Bone Profiler Directions for Use

1. Attach Bone Profiler to the appropriate delivery tool:
 - Powered use - contra-angle handpiece drill.
 - Manual use - Low Torque Indicating Ratchet Wrench Standard ISO 1797 Adapter [C9980].

NOTE: If applicable, remove excess bone that may have grown over the cover screw and remove cover screw prior to Bone Profiler use.



2. Insert the Bone Profiler into the placed implant. Ensure the Bone Profiler guide pin is aligned coaxially with the implant.

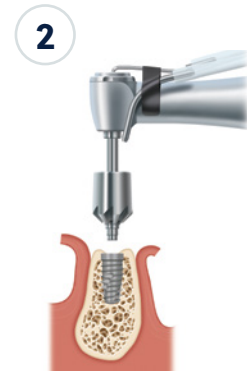

3. Once the Bone Profiler is seated onto the implant site:
 - Powered use - start the handpiece drill rotating at or below 50 rpm, clockwise.
 - Manual use - begin rotating the Bone Profiler clockwise.

Apply light pressure in the direction of the implant. The Bone Profiler will gradually cut away the excess bone from around the coronal aspect of the implant to allow prosthetic components to fully seat.

NOTE: For optimal cutting, ensure cutting teeth are clear of collected debris. Excess debris may result in poor performance of the Bone Profiler, which could lead to implant connection damage.



4. Continue cutting away at the bone until the Bone Profiler no longer removes bone and excess bone has been sufficiently reduced to allow for proper seating of prosthetic components.

NOTE: Ensure that the implant platform is cleaned from bone remnants prior to seating the restorative component.

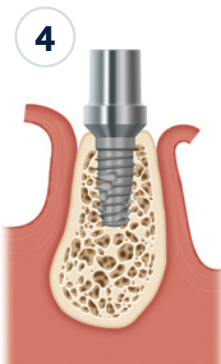

Healing Components

Encode® Healing Abutments

The Encode Emergence Healing Abutment is a 3-in-1 two-piece healing abutment/impression coping/scan-body designed to facilitate gingival tissue healing and consists of an abutment and retaining screw that are assembled together.

Encode Emergence Healing Abutments have the Encode Coding scheme on the occlusal surface and a hex connection at the base of the healing abutment that engages the hex with the implant for orientation and anti-rotation. The case can be designed by an Encode Empowered laboratory or ZimVie. Please contact a ZimVie representative for additional information.

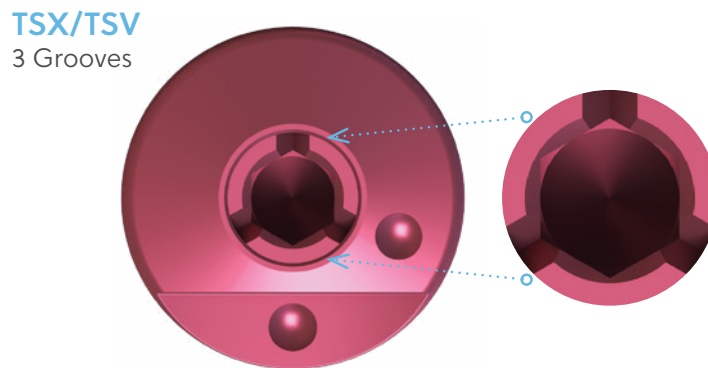

Healing Collar Selection Guidelines

Selecting a Healing Collar:

- Determine the size of the implant platform.
- Select the emergence profile that best suits the site being restored. The profile should match the transfer and/or abutment to be used.
- Select the height so that the top of the component protrudes slightly above the surrounding tissue.

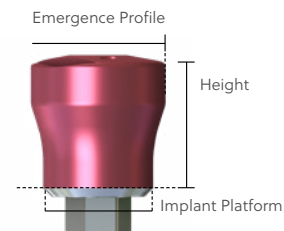

HC3/TEHA3/TEEHA3 = 3.5 mmD (Implant Platform) Healing Collar

HC4/TEHA4/TEEHA4 = 4.5 mmD (Implant Platform) Healing Collar

Example:

TEEHA333 = 3.5 mmD (Implant Platform) Healing Abutment, 3.8 mmD Emergence Profile, 3.0 mm Height (middle digit equals profile, last digit equals height)

HC343 = 3.5 mmD (Implant Platform) Healing Collar, 4.5 mmD Emergence Profile, 3.0 mm Height (second digit equals profile, third digit equals height)

For additional information on surgical placement, please visit zimvie.com/encode

Encode Emergence Healing Abutment for TSX Implants*

Implant Platform	Emergence Profile	Height		
		3.0 mm	5.0 mm	7.0 mm
● 3.5 mmD	3.8 mmD	TEEHA333	TEEHA335	TEEHA337
● 3.5 mmD	5.0 mmD	TEEHA353	TEEHA355	TEEHA357
● 3.5 mmD	6.5 mmD	TEEHA363	TEEHA365	TEEHA367
● 4.5 mmD	4.5 mmD	TEEHA443	TEEHA445	TEEHA447
● 4.5 mmD	5.5 mmD	TEEHA453	TEEHA455	TEEHA457
● 4.5 mmD	6.5 mmD	TEEHA463	TEEHA465	TEEHA467
● 4.5 mmD	7.5 mmD	TEEHA473	TEEHA475	TEEHA477



Encode Healing Abutments for TSX Implants

Implant Platform	Emergence Profile	Height		
		3.0 mm	5.0 mm	7.0 mm
● 3.5 mmD	3.8 mmD	TEHA3383	TEHA3385	TEHA3387
● 3.5 mmD	5.0 mmD	TEHA3503	TEHA3505	•
● 4.5 mmD	5.0 mmD	TEHA4503	TEHA4505	•
● 4.5 mmD	5.6 mmD	TEHA4563	TEHA4565	TEHA4567
● 4.5 mmD	6.0 mmD	TEHA4603	TEHA4605	•



*Not available in all markets.

Healing Collars

Implant Platform	Emergence Profile	Cuff Height		
		1.5 mm	3.0 mm	4.5 mm
● NP (2.9 mmD)	3.7 mmD	CHCNP31	CHCNP33	CHCNP34
● NP (2.9 mmD)	4.5 mmD	CHCNP41	CHCNP43	CHCNP44

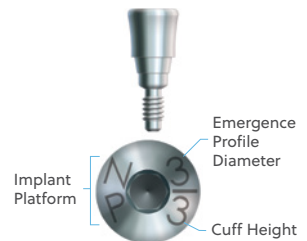

Implant Platform	Emergence Profile	Height		
		3.0 mm	5.0 mm	7.0 mm
● 3.5 mmD	3.5 mmD (No Flare)	HC333	HC335	•
● 3.5 mmD	4.5 mmD	HC343	HC345	HC347
● 3.5 mmD	5.5 mmD	HC353	HC355	•
● 4.5 mmD	4.5 mmD (No Flare)	HC443	HC445	•
● 4.5 mmD	5.5 mmD	HC453	HC455	HC457
● 4.5 mmD	6.5 mmD	HC463	HC465	•

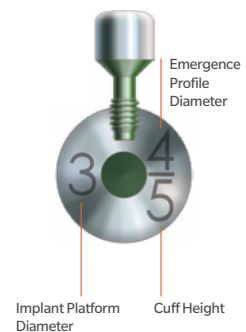

For more information, visit [ZimVie.com](https://www.ZimVie.com)

ZimVie

4555 Riverside Drive
Palm Beach Gardens, FL 33410
1-800-342-5454
Phone: +1-561-776-6700
Fax: +1-561-776-1272



Some content herein is protected by copyright, trademarks, and other intellectual property rights, as applicable, owned by or licensed to 3Diemme SRL or its affiliates unless otherwise indicated, and must not be redistributed, duplicated, republished or reprinted, in whole or in part, without express written consent of the owner. Unless otherwise indicated, as referenced herein, all trademarks and intellectual property rights are the property of ZimVie Inc. or an affiliate; and all products are manufactured by one or more of the dental subsidiaries of ZimVie Inc. (Biomet 3i, LLC, Zimmer Dental, Inc., etc.) and marketed and distributed by ZimVie Dental and its authorized marketing partners. For additional product information, please refer to the individual product labeling or instructions for use. ZTIRW is manufactured by Elos Medtech Pinol A/S and distributed by ZimVie Dental. Product clearance and availability may be limited to certain countries/regions. This material is intended for clinicians only and does not comprise medical advice or recommendations. Distribution to any other recipient is prohibited. This material may not be copied or reprinted without the express written consent of ZimVie. ZVINST0015 REV C 10/23 ©2023 ZimVie. All rights reserved.

